

PCWSW6020FL WorkSight® System

QUICK INSTALLATION GUIDE



Powered by
PRECO
ELECTRONICS

1 Before You Start

Contents:
 WS6220 Sensor (1)
 Sensor Mounting Hardware: 4 each - 1 1/4" x 10-24 Bolts, Locking Hex Nuts, and Flat Washers
 WSZ-BK90 Sensor Bracket (1) (shown on back)

Cables (2)
 WS-FLBH Cable
 WS-CH Cable

PVP760 Camera System (1)
 (1) PVP710 Monitor
 (1) CPK732 Camera / Cable
 (1) CPC700 Camera
 (1) DDC023C Cable

Mounting Hardware, (2) Monitor brackets, (1) Camera bracket, (4) Trigger Wires, power adapter, and sun shield (not shown)
 User Manuals and Drill Template



2 Mount Sensor

Select a location for the sensor approximately 3ft/1M from the ground. Ideally the sensor should be centered on the rear of the vehicle. The sensor face should be perpendicular to the ground with the 'PreView' graphic oriented as shown below.

Important!
 Before the PreView Sensor is permanently installed to the vehicle, verify the selected location provides a clear detection zone. Temporarily attach the sensor in the proposed location, apply power to the system, and verify nothing is detected.

Mounting
 The sensor may be mounted directly on the vehicle or attached using the supplied bracket. Using the drill template, scribe position marks through the holes and drill 1/4" (6mm) holes centered at the marks. A 1 1/2" diameter clearance hole is required for the sensor connector and the mating cable. Secure the sensor to the vehicle with the supplied hardware. Apply a maximum of 22" pounds to secure the sensor.



Note orientation: THIS SIDE UP

3 Install Cables

Routing the body harness and camera cables should start at the rear of the vehicle and end in the cab. Allow a small service loop in the cables at the camera or sensor and secure the cables every few feet (~1M) with tie wraps. To enter the cab, drill a 1" (24mm) hole and feed the connector through to connect to the cab harness. Connect the cab harness to the monitor. Connect the red and black wires as indicated. Route the remaining length of cable to the Monitor.

Important!
 The sensor mating connector is fully waterproof if mated properly. Do not route cable next to heat sources or area that may see abrasion or rock and debris damage. Bundle and store any excess cable.



4 Mount Monitor and Camera

Mount the monitor in a location easily viewed by the driver. Use supplied hardware. Wiring detailed on the back of this document.

Mount the camera on the rear of the vehicle to achieve the best possible view of the area. Use the supplied hardware.

Wire Connections Wiring Diagram



Back Page

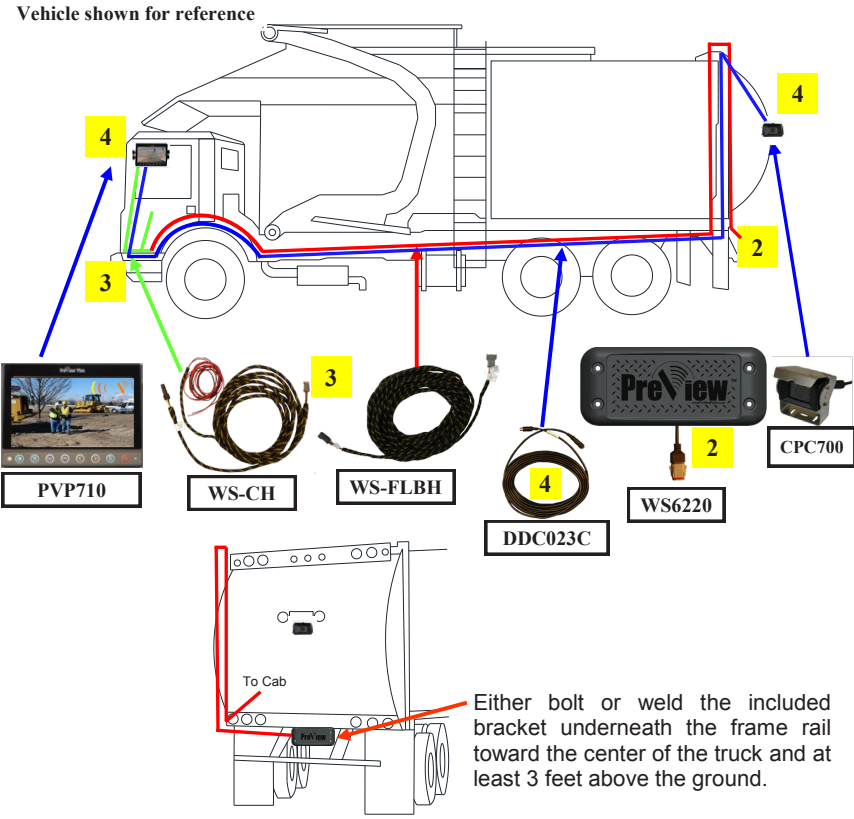

The quick install guide is only a supplement to the product manuals. Please read all of the manuals for complete information and instructions before installing the product.



PCWSW6020FL WorkSight® System

QUICK INSTALLATION GUIDE



Powered by
PRECO
ELECTRONICS

Initial System Power Up and Test

Once the sensor and camera system are installed, wired, and connected, power should be applied to test system operation. The monitor should power up and display the camera view. The vehicle must be placed in reverse to power up the sensor. Any detection will be indicated on the monitor, check for any obstructions that may be detected by the sensor. If possible, move the sensor so it does not detect the object(s). If it is not possible to relocate the sensor, contact Preco Electronics, Inc™.

If for some reason the system is malfunctioning, the  will change to a yellow triangle indicating a failure. Refer to the Troubleshooting section in the monitor manual to determine the error and potential causes.

Once the system has been installed and verified, the detection zone should be tested. The test should be performed with two people, one who remains in the cab (the operator), and one who walks through the sensor field to the rear of the vehicle (the assistant). The operator engages the parking brake, presses the vehicle brake, and places the vehicle in reverse. The assistant then walks through the detection zone while the operator notes where the monitor displays a detection. An accurate detection zone can be mapped by moving about the rear of the vehicle and noting when the monitor displays a detection.

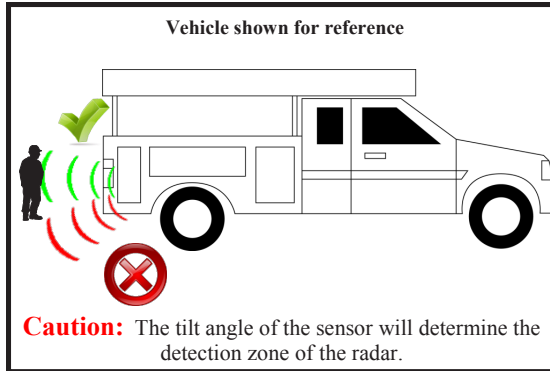



The PreView® Radar System is designed to supplement other safety practices and/or devices, it is not to be the sole method of collision avoidance. The machine operator is always the first line of defense when safely operating a vehicle.

TESTING / MAINTENANCE

Test the PreView® Radar System every day for functionality and performance prior to vehicle operation, refer to the sensor manual.

MONITOR OVERLAY GRAPHICS

-  SENSOR POWER / NO DETECTION
-  NO SENSOR COMMUNICATION
-  DETECTING OBJECTS

Reference Monitor Manual for additional information

