



Cole Hersee®
A Littelfuse® Brand



Manufacturing switches since 1924

 **APS**
LIGHTING & SAFETY
www.aps-supply.com

APS USA
610 Gateway Center Way, Suites J & K
San Diego, CA 92102 USA
P: 1 619 263 4164
F: 1 619 263 6814

APS Australia
U48 / 9 Vision Street,
Wangara, WA 6065 Australia
Phone: 61 (8) 9302 2369
Fax: 61 (8) 6305 0047

APS: Singapore
Mexico
Colombia
Chile
Perú

History - Manufacturing switches since 1924

Cole Hersee has been designing and manufacturing reliable electrical switches for vehicles for over 90 years and have been recognised for innovative products throughout their history.

As the original designer and patent holder, Cole Hersee switches and connectors made today are specified by OEMs and used as high-quality replacement parts.

Although 1924 is taken as the date Cole Hersee was established, antecedents go back even further to the dawn of the automobile age: The Henry Cole Company of Boston was founded in 1914!

Cole Hersee are a leading manufacturer of electromechanical, electronic & digital switches and connectors, designing dependable products for a broad range of vehicles.

Since its founding in 1924, Cole Hersee has been a pioneer and leader in the development of heavy-duty electrical products for the vehicle industry, earning a reputation for quality and value.

Cole Hersee collaborated on many basic industry standards and today is a preferred supplier of over 2,000 dependable vehicle products and accessories. Cole Hersee is ISO 9001:2008 certified.

Cole Hersee was acquired by Littelfuse, Inc. in 2010.

Partnership - Cole Hersee is proudly supplied across Australia and New Zealand by ESG Asia Pacific

ESG Asia Pacific are currently, and have been, the exclusive Australian and New Zealand distributor of Cole Hersee for over 20 years.

Brands of ECCO Safety Group



It's not how much you save, it's what and who you save

What would happen if you couldn't shut off the power in an emergency?
What would happen if the power was accidentally switched on while someone was working on a machine? What would happen if you couldn't securely lock off your machinery—only to have it then damaged, vandalised, or stolen?

Beware of inferior and copy products

Cheap copy components can cause expensive damage to equipment and put lives at risk. Cole Hersee products are renowned for quality and reliability that will protect you, your workers, and your valuable vehicles and equipment.



GENUINE COLE HERSEE

75910 BATTERY MASTER SWITCH

Cole Hersee 75910 Battery Master Switches are designed and built to not only withstand harsh mining environments, but also to ensure that when the switch is on or off, it stays on or off—without any chance of it being accidentally switched or deliberately tampered with.

This battery master switch was developed by ESG Asia Pacific in conjunction with Cole Hersee and major mining corporations, to service specific safety requirements.

The 75910 has an extended actuation point to prevent accidental actuation even when a lockout lever is in use.

For more features and specifications on this switch please see page 9.

Cole Hersee 75904 with a standard 4° actuation point

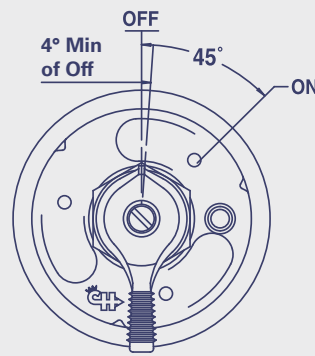

Cole Hersee 75910 with an extended 17° actuation point

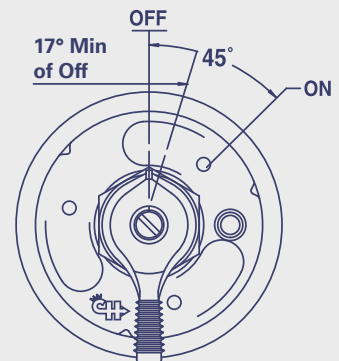

Battery Master Switches

Page 8

For over 40 years Cole Hersee has been designing and building heavy duty Battery Master Switches that have been installed as OEM equipment by leading manufacturers of heavy duty vehicles.

Battery Master Switches shut down a vehicle's electrical system by cutting off current from the battery. They are designed to help prevent tampering, theft, battery drain and electrical fires.

Battery Master Switches are available with brass or plated steel cases and are actuated by lever or hencol key. Contacts are either silver or copper. O-rings feature in the operating shaft of some models for additional moisture and dirt protection.



Rocker & Toggle Switches

Page 18

Rocker & Toggle Switches are manufactured in many different variations to handle most vehicle and equipment applications and are usually classified by the number of poles and throws to identify their basic operation.

Cole Hersee Toggle Switches are available with ball, short or long handles, paddle or illuminated actuators. Housings are either plastic, plastic and metal combined, or die-cast metal.

Rocker Switches can be either snap-in or bracket mounting, actuators can be illuminated or imprinted, contain pilot lights, or have both pilot lights and imprinting.



Push Button Switches

Page 40

Push Button Switches (sometimes referred to as momentary switches) are most commonly used for Off/Mom On ignition type applications.

Cole Hersee Push Button Switches are available in die-cast alloy or brass housing with most featuring chrome plated button and face nut or rubber capping.



Rotary Switches

Page 44

Rotary Switches are usually used for special purpose applications including headlamp and windscreen wiper operation. The Cole Hersee range features models which can be used for more common applications.

Cole Hersee Rotary Switches are available in die-cast alloy or nylon housing with most featuring a nylon knob to fit in with your existing vehicle interior.



Ignition Switches

Page 48

Ignition Switches are operated by a coded key and tumbler lock, hencol keyed lock or lever. Lever design is available in three different configurations: short, long and military. Ignition Switches are available with coded cylinder locks and keys or hencol non-tumbler locks with compatible keys.

Switches are available with a grounded case design with a separate ground terminal. A grounded case switch must be installed in a metal panel which is part of the vehicle earthing system.



Solenoids

Page 52

A Solenoid is an electromagnetic relay used in a direct current wiring system between a low current capacity switch and a high current load requirement.

In an engine starting system, the Ignition Switch in the start position may have a rating of 5 amps whilst the starter motor may have a cranking requirement of 200 to 350 amps.

Once energised by the Ignition Switch, the Solenoid coil moves the high current capacity contact to a closed position, thereby energising the starter motor.



Circuit Breakers

Page 62

Cole Hersee Circuit Breakers are designed and engineered for responsive performance over a long period. Casings are manufactured from either high quality plated steel or durable plastic.

Cole Hersee Circuit Breakers are designed and engineered for responsive performance over a long product life.

All Cole Hersee Circuit Breakers conform to SAE Standard J553.



Connectors and Electrical

Page 66

The Cole Hersee range includes high quality connectors and electrical equipment such as heavy duty trailer connectors, battery studs & jumpers, headlight connectors and electronic units.

Cole Hersee trailer connectors are built to withstand the rigors of trucking thousands of kilometres in dust and dirt, heat and cold, yet maintain the all-important electrical continuity between vehicle and trailer.



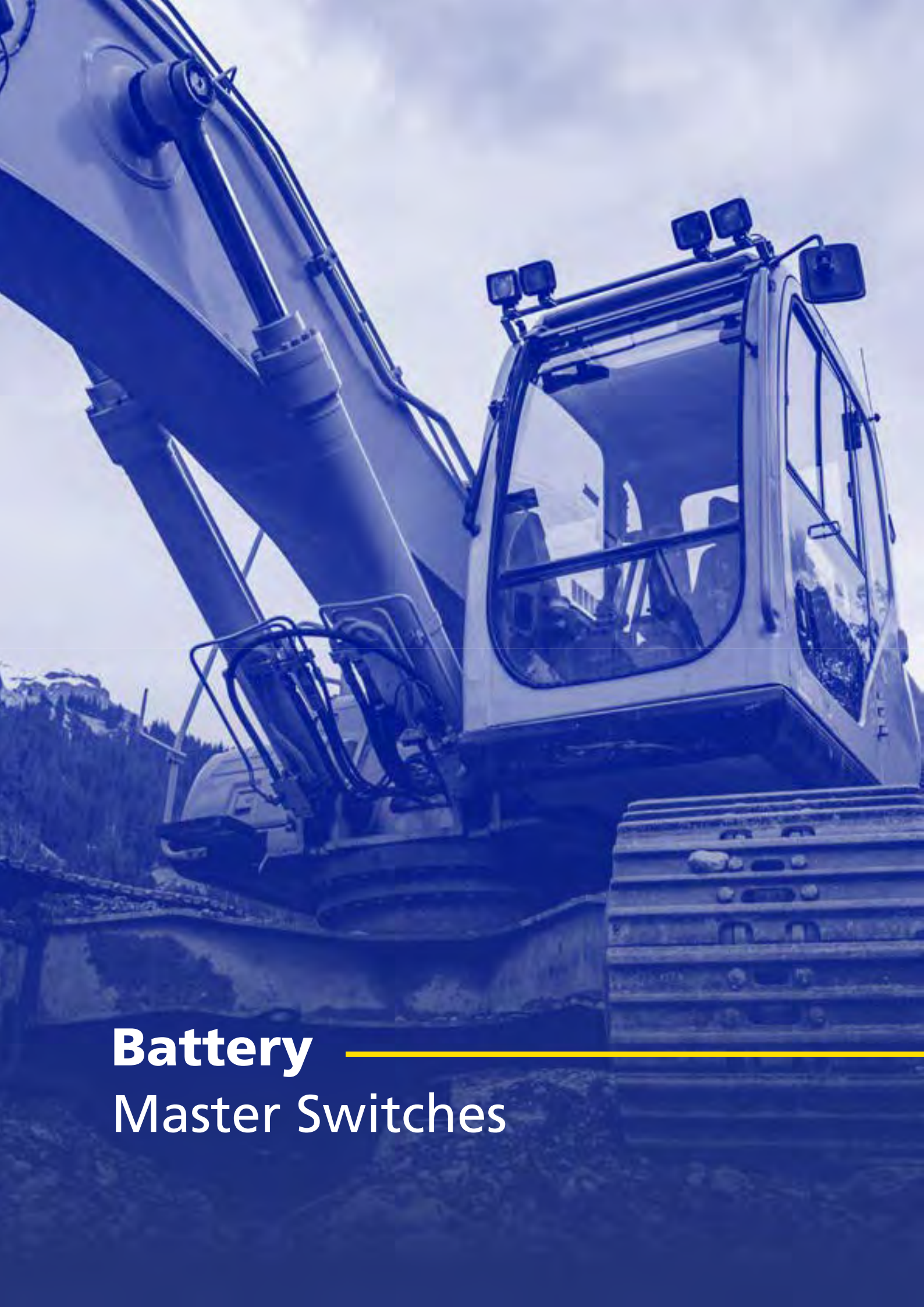

Battery

Master Switches

BATTERY MASTER SWITCHES

For over 40 years Cole Hersee has been designing and building heavy duty Battery Master Switches that have been installed as OEM equipment by leading manufacturers of heavy duty vehicles.

Battery Master Switches shut down a vehicle's electrical system by cutting off current from the battery. They are designed to help prevent tampering, theft, battery drain and electrical fires.

Battery Master Switches are available with brass or plated steel cases and are actuated by lever or hencol key.

Contacts are either silver or copper. O-rings feature in the operating shaft of some models for additional moisture and dirt protection.



DPST On/Off Battery and Field Master Silver

75910BX

Australia's most reliable Battery Master Switch was developed by Cole Hersee in conjunction with ESG Asia Pacific and major mining corporations, to service a specific requirement.

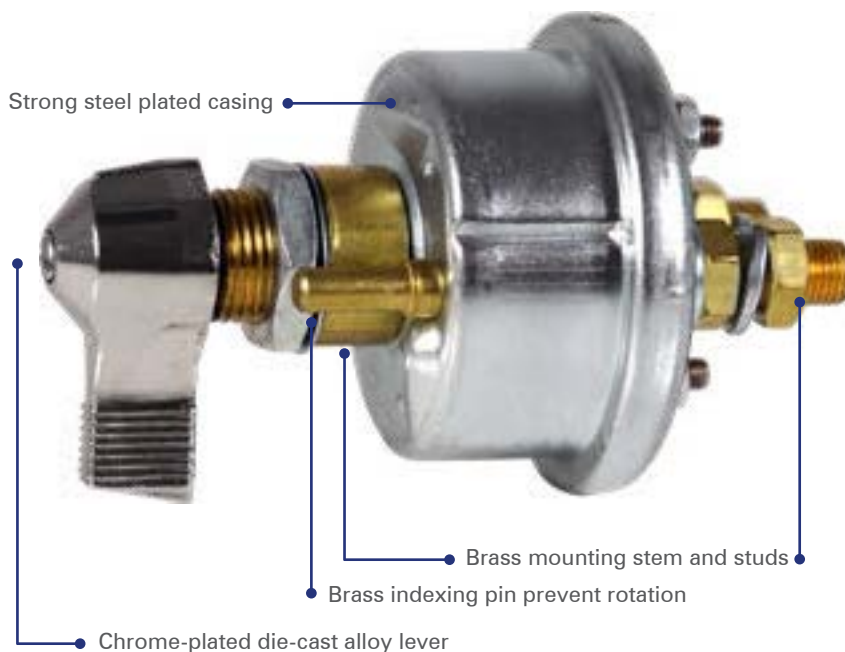

Features

- + Silver contacts, chrome lever
- + Weather resistant, O-ring sealed

Specifications





| | |
|----------|----------------------|
| Voltage | 6V-36V Multivoltage |
| Amperage | 1000A Int, 125A Cont |

Part Numbers

| | |
|---------|-------|
| 75910BX | Boxed |
|---------|-------|

BATTERY MASTER SWITCHES

SELECTION GUIDE

| Part Number | 24024 | 75903 | 75904 | 75907 | 75910 |
|-------------------------------------|---|---|---|---|---|
| Battery Inputs | 1 | 2 | 2 | 2 | 2 |
| Switch Positions | 2 | 2 | 2 | 2 | 2 |
| Alternator Field Disconnect (AFD) | No | Yes | Yes | Yes | Yes |
| Make Before Break Contact | No | Yes | Yes | Yes | Yes |
| Maximum Operating Voltage | 36V DC | 36V DC | 36V DC | 36V DC | 36V DC |
| Continuous Rating (studs) | 175A | Large: 175A Small: 20A | Large: 175A Small: 20A | Large: 300A Small: 20A | Large:125A Small: 20A |
| Intermittent Rating (5 min) | 400A | 1000A | 400A | 1000A/20A | 800A/20A |
| Cranking Rating (30 sec) | N/R | 1000A | 1000A min | 1000A/20A min. | 800A/20A min |
| Inrush Rating | 400A | 1000A | 1000A | 1000A/20 | 1000A/20 |
| Cable Size required to Meet Ratings | 1/0 | 2/0 | 2/0 | 4/0 | 2/0 |
| Temperature Range | -40 to +85°C | -40 to +85°C | -40 to +85°C | -40 to +85°C | -40 to +85°C |
| Terminal Stud Size | 3/8"-24 | 3/4"-16 | 3/4"-16 | 3/4"-16 | 3/4"-16 |
| Terminal Stud Length | 0.690" (17.5mm) | 0.690" (17.5mm) | 0.690" (17.5mm) | 0.690" (17.5mm) | 0.690" (17.5mm) |
| Maximum Terminal Stud Torque | 8-10 Nm | 8-10 Nm | 8-10 Nm | 8-10 Nm | 8-10 Nm |
| Terminal Stud Material | Brass | Copper | Brass | Copper | Brass |
| Lock Out/Tag Out | with 24505 | with 24505 | with 24505 | with 24505 | with 24505 |
| Actuator | 2 Prong Key | Chrome Lever | Chrome Lever | Diecast Lever | Chrome Lever |
| Ignition Protected | No | No | No | No | No |
| Ingress Protection | IP55 | IP55 | IP55 | IP64 | IP64 |
| Mounting Stem | 3/4"-16 | 3/4"-16 | 3/4"-16 | 3/4"-16 | 3/4"-16 |
| Anti-Rotation Pin | Yes | No | No | Yes | Yes |
| |  |  |  |  |  |

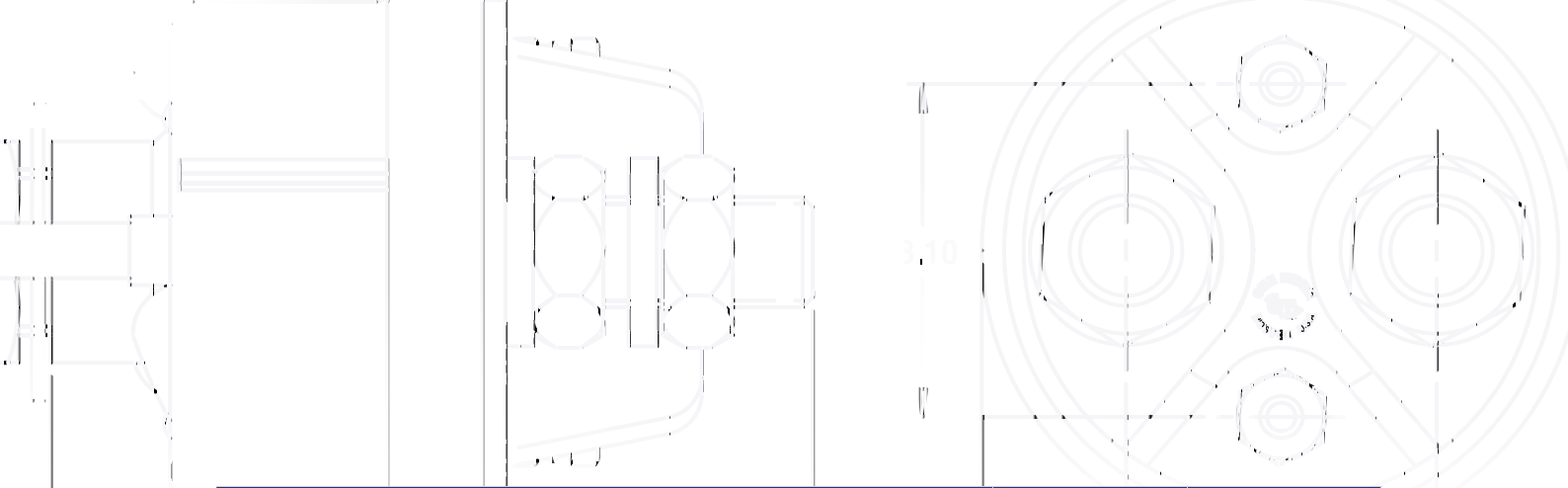

| 75912 | 75920 | 75920-01 | 880175 | 880175-0001 | 880175-0002 |
|---|---|---|---|---|---|
| 2 | 1 | 1 | 2 | 2 | 2 |
| 2 | 2 | 2 | 2 | 2 | 2 |
| No | No | No | No | No | No |
| No | N/A | N/A | No | No | No |
| 36V DC | 36V DC | 36V DC | 48V DC | 48V DC | 48V DC |
| 2 X 125A | 400A | 400A | 500A | 500A | 500A |
| 2x 750A | 400A | 400A | 1000A | 1000A | 1000A |
| 750A each min. | 2,000A | 2,000A | 2,250A | 2,250A | 2,250A |
| 2x 1000A | 2,000A | 2,000A | 3,000A (1 sec) | 3,000A (1 sec) | 3,000A (1 sec) |
| 2/0 | 4/0 | 4/0 | 4/0 | 4/0 | 4/0 |
| -40 to +85°C | -40 to +85°C | -40 to +85°C | -50 to +85°C | -50 to +85°C | -50 to +85°C |
| 3/4"-16 | 3/4"-16 | 3/4"-16 | M12 | M12 | M12 |
| 0.690" (17.5mm) | 3/4" (19mm) | 3/4" (19mm) | 0.984" (25mm) | 0.984" (25mm) | 0.984" (25mm) |
| 8-10 Nm | 8 Nm | 8 Nm | 30 Nm | 30 Nm | 30 Nm |
| Brass | Tin-Plated Copper | Tin-Plated Copper | Tin-Plated Copper | Tin-Plated Copper | Tin-Plated Copper |
| with 24505 | Yes | Yes | Yes | Yes | Yes |
| Chrome Lever | Red Knob | Yellow Knob | Black Knob | Red Knob | Yellow Knob |
| No | No | No | SAE J11 & ISO 8846 | SAE J11 & ISO 8846 | SAE J11 & ISO 8846 |
| IP64 | IP68 | IP68 | IP67 & IP69K | IP67 & IP69K | IP67 & IP69K |
| 3/4"-16 | 3/4"-16 | 3/4"-16 | N/A | N/A | N/A |
| Yes | Yes | Yes | - | - | - |
|  |  |  |  |  |  |

DPST On/Off Battery Master Switch Lockout

24505-01

This Cole Hersee Battery Master Switch will disconnect the battery and the alternator or generator field circuit.

The 75910 Cole Hersee Battery Master Switch is the Australian approved switch by major mining corporations.

For peace of mind use a Cole Hersee lockout lever and flange plate that can accept a padlock to securely lock a Disconnect Switch in the Off position.

Features

- DPST, Silver contacts, chrome lever
- Weather resistant, O-ring sealed
- Field terminals 20A continuous
- Indexing pin aligns switch and prevents rotation
- 2 x Field stud 10-32
- 2 x Battery stud 3/8"-24
- Mounting stem 3/4"-24 thread, L 13mm
- Suits panel thickness to 6.5mm
- Accepts padlocks up to 6mm diameter

Specifications

| | |
|---------------|--|
| Voltage | 6V-36V Multivoltage |
| Amperage | 1000A Intermittent, 125A Continuous, Small: 20A Cont |
| Dimensions | H 110 x Ø 67 |
| Configuration | DPST |
| Modes | On/Off |
| Application | Heavy Duty, Mining |

Lever Part Numbers

- 24505-01B Chrome Lever
- 24505-01RB Red Lever
- 24505-01YB Yellow Lever



Master Battery Disconnect Switch SPST On/Off

75920BX

Features

- Strong black ABS body
- Copper Studs
- Built-in lock-out / tag-out
- Indexing pin aligns switch and prevents rotation
- O-ring seal on mounting shaft
- Red or yellow locking actuator handle
- 2 x Battery studs 3/8"-24
- Mounting stem 3/4"-16 thread, L22mm
- Suits panel thickness 12mm
- IP68 waterproof and dust proof; switch can be mounted in exposed locations

Specifications

| | |
|---------------|--|
| Voltage | 6V-36V Multivoltage |
| Amperage | 300A Continuous, 1000A to 3000A Intermittent |
| Dimensions | H 136 x D 86 x W x 70 |
| Configuration | SPST |
| Modes | On/Off |
| Application | Heavy Duty, Mining, Agriculture, Marine |

Part Numbers

- 75920BX Red Handle
- 75920-01BX Yellow Handle



TR Dual Pole Heavy Duty Battery Master Switch

880175BX

This dual pole 500A Battery Master Switch cuts all battery power from vehicle electrical systems with applications needing switching of two circuits, or both positive and negative.

Features

- 2 x Battery studs 3/8"-24
- Built-in lock-out / tag-out
- Terminal stud size: M12 x 25mm.
- Temperature range: -50° to 85°C, DC-Rated to 105°C
- Shock: 30G, Vibration: 8G
- IP67 waterproof and dust proof; switch can be mounted in exposed locations

Specifications

- Voltage 6V-48V Multivoltage
- Amperage 500A Continuous, with 2 x 4/0 input and 2 x 4/0 output cables
- Dimensions H 85 x D 103 x W x 120
- Configuration DPST
- Modes On/Off

Part Numbers

- 880175BX Black Handle
- 880175-0001BX Red Handle
- 880175-0002BX Yellow Handle



Battery and Field Master Switch DPST On/Off

75907BX

This Battery and Field Master Switch will disconnect the battery and the alternator or generator field circuit.

Features

- Battery and Field Master Switching
- Silver contacts, chrome lever
- Weather resistant, O-ring sealed
- Field terminals 20A continuous
- Indexing pin aligns switch and prevents rotation
- 2 x Field stud 10-32
- 2 x Battery stud 3/8"-24
- Mounting stem 3/4"-24 thread, L 13mm
- Suits panel thickness to 6.5mm

Specifications

- Voltage 6V-36V Multivoltage
- Amperage 2000A Intermittent, 300A Continuous, Small: 20A Cont
- Dimensions H 110 x Ø 67
- Configuration DPST
- Modes On/Off
- Application Heavy Duty, Mining

Part Numbers

- 75907BX Boxed

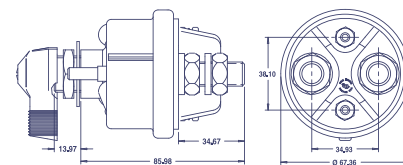

Battery and Field Master Silver DPST On/Off

75904BX

This Battery and Field Master Switch will disconnect the battery and the alternator or generator field circuit.

Features

- Battery and Field Master Switching
- Silver contacts, chrome lever
- Weather resistant, O-ring sealed
- Field terminals 20A continuous
- Indexing pin aligns switch and prevents rotation (key start only)
- 2 x Field stud 10-32
- 2 x Battery stud 3/8"-24
- Mounting stem 3/4"-24 thread, L 13mm
- Suits panel thickness to 6.5mm

Specifications

- Voltage 6V-36V Multivoltage
- Amperage 1000A Intermittent, 125A Continuous, Small: 20A Cont
- Dimensions H 91 x Ø 67
- Configuration DPST
- Modes On/Off
- Application Heavy Duty, Mining

Part Numbers

- 75904BX Lever switch
- 75904-03BX Key start switch



Indexing pin (key start only)

Battery and Field Master Copper DPST On/Off

75903BX

This Battery and Field Master Switch will disconnect the battery and the alternator or generator field circuit.

Features

- Battery and Field Master Switching
- Copper contacts, chrome lever
- Weather resistant
- Field terminals 20A continuous
- 2 x Field stud 10-32
- 2 x Battery stud 3/8"-24
- Mounting stem 3/4"-24 thread, L 13mm
- Suits panel thickness to 6.5mm

Specifications

- Voltage 6V-36V Multivoltage
- Amperage 1000A Intermittent, 125A Continuous, Small: 20A Cont
- Dimensions H 110 x Ø 67
- Configuration DPST
- Modes On/Off

Part Numbers

- 75903BX Boxed

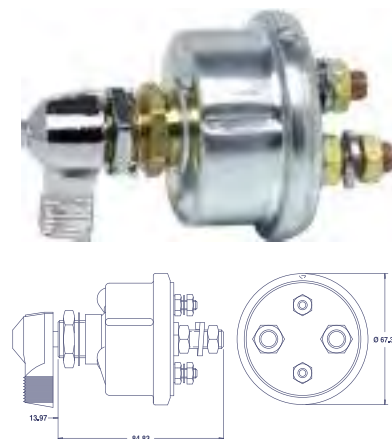

Dual Battery Master Switch 4 Main Studs DPST

75912BX

This switch can be used to switch positive and negative at the same time, or for two separate circuits.

Features

- Suitable for two high current loads
- Silver contacts, chrome lever
- Weather resistant, O-ring sealed
- Battery 4 x stud 3/8"-24 studs
- Indexing pin aligns switch and prevents rotation
- Mounting stem 3/4"-24 thread, L 13mm
- Suits panel thickness to 6.5mm

Specifications

- Voltage 6V-36V Multivoltage
- Amperage 750A Intermittent x 2, 125A Continuous x 2
- Dimensions H 110 x Ø 67
- Configuration DPST
- Modes On/Off
- Application Heavy Duty, Mining

Part Numbers

- 75912BX Boxed

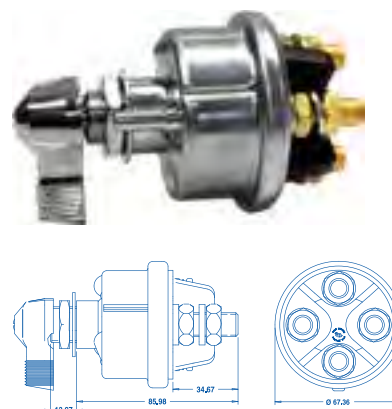

Marine Battery Master Switch DPST On/Off

M290-05BX

This Marine Battery Master Switch will disconnect the battery preventing drain.

Features

- Silver laminated contacts
- Brass case, chrome lever
- Field term 20A continuous
- 2 stud terminals 10-32
- Mounting stem 3/4"-24 thread
- Mounting stem length 46mm
- Suits panel thickness up to 23mm
- UL rating 707B

Specifications

- Voltage 6V-36V Multivoltage
- Amperage 800A Intermittent, 125A Continuous, Small: 20A Cont
- Dimensions H 86 x Ø 67
- Configuration DPST
- Modes On/Off
- Application Heavy Duty, Marine

Part Numbers

- M290-05BX Boxed

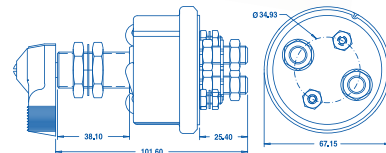

CAT OEM Battery Master SPST On/Off with Key

24024BX

CAT OEM Battery Master Switch replaces 7N0718

Features

- Two prong key type
- Silver laminated contacts, chrome lever
- Weather resistant O-ring sealed
- Indexing pin aligns switch and prevents rotation
- 2 stud terminals 10-32
- Mounting stem 3/4"-24 thread, L 13.5mm
- Suits panel thickness 6.5mm to 19mm

Specifications

- Voltage 6V-36V Multivoltage
- Amperage 1000A Intermittent, 125A Continuous
- Dimensions H 86 x Ø 67
- Configuration SPST
- Modes On/Off
- Application Heavy Duty, Mining

Part Numbers

- 24024BX Boxed





M750 Series

BATTERY MASTER SWITCHES

In a dual battery system, one battery is used for starting the engine while the other is used to power auxiliary loads. A battery selector switch enables the use of the first battery, the second battery or both batteries simultaneously.

A dual battery system with a battery selector switch provides backup starting power in an emergency. One application is to put two batteries together (in parallel) to start the engine in cold weather.

If the primary battery is not at full power, the second battery can be used. This assures the availability of adequate power for starting. It also enables the user to select either battery for charging.

It will provide battery disconnect, protection against electrical fire, tampering, theft and battery drain when the vehicle, equipment or boat is unattended.

When using a dual battery charger it is necessary to separate the batteries while the charger is operating.

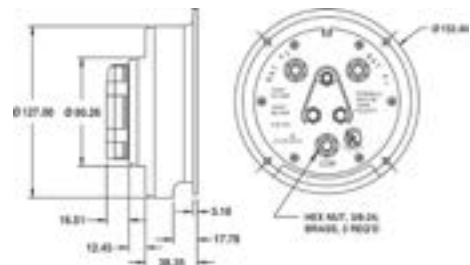
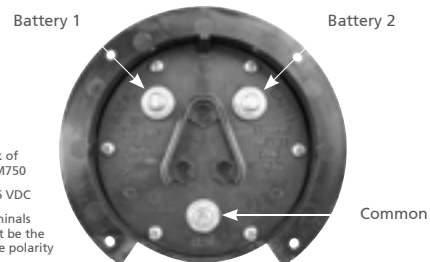
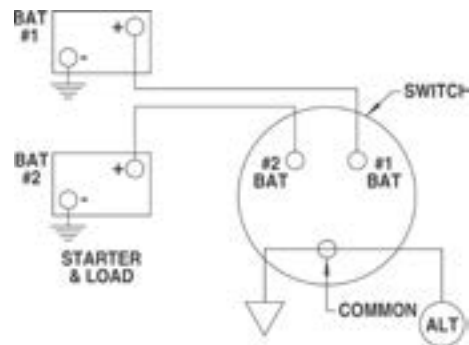

The batteries must be independent of each other for the dual battery charger to operate properly. The selector switch must be turned to the OFF position to avoid damage to the charger.

Dual Battery Switch Selector and Disconnect

M750

This Dual Battery Switch Selector and Disconnect switch will suit any vehicle that needs to use two batteries where one battery is used for starting the engine, while the other is used to power auxiliary loads. UL rating 707B.

This is a common situation in trucks, boats, RVs, police and rescue vehicles, and in ambulances and fire equipment.

Features

- High impact and plastic case and knob
- High temperature engineered plastic
- 4 Position dual battery control
- Heavy duty copper stud terminals 3/8

Specifications

- Voltage 6V-36V Multivoltage
- Amperage 500A Intermittent, 310A Continuous
- Dimensions H 67 x Ø 127
- Modes 1: Batteries OFF
2: Battery #1 ON
3: Battery #1&2 ON
4: Battery #2 ON
- Application Heavy Duty

Part Numbers

- M750 Clam blister





Rocker ---

& Toggle Switches

ROCKER & TOGGLE SWITCHES

Rocker and Toggle Switches are manufactured in many different variations to handle most vehicle and equipment applications. Rocker and Toggle Switches are usually classified by the number of poles and throws to identify their basic operation.

Rocker switches can be either snap-in or bracket mounting, actuators can be illuminated or imprinted, contain pilot lights, or have both pilot lights and imprinting. Housings are usually plastic, however some models feature plastic with a metal bezel or mounting bracket.

Toggle switches are available with ball, short or long handles, paddle or illuminated actuators. Housings are either plastic, plastic and metal combined, or die-cast metal.

Cole Hersee Rocker and Toggle Switches can be used in 6, 12, 24 and 36 volt systems, and are rated up to 35 amp inductive load and 25 amp lamp load at 12 volts.

They can be used in applications such as signalling and marker lamps, windshield wiper systems, fuel selector valves, heater systems, headlight systems, and more.

Amperage requirements differ from application to application. Clearance and marker lamps on a 12 volt truck system for example, can require from less than one to just over two amps to operate. Other applications may require anywhere from five to eight amps.

When switches are turned On or Off, they must handle more current or voltage than is required to operate in a steady state—Cole Hersee switches are built to handle these requirements.



Weather Resistant Features

A PVC (Polyvinyl Chloride) coating is applied to the switch body for effective sealing and protection from moisture, dirt and the elements. PVC coated switches usually come with wire leads that permit complete covering and insulation of the terminals.

Neoprene seals (O-rings) within the mounting stem protect against moisture and dirt from entering around the base of the actuator handle.

Also available are protective durable Silicone Rubber Boots that fit over the toggle handles and fasten securely to the mounting stem, making the toggle switch adaptable for use where moisture, dirt and similar elements are present.

Available in two styles: one covers the entire toggle handle (81264), the other allows the handle to protrude (81255).



Part Numbers

| | | | |
|--------------|---------|--------------|-------------|
| • 81264BX | • Grey | • 81264-05BX | • Red |
| • 81264-01BX | • Black | • 81264-07BX | • Yellow |
| • 81264-02BX | • Blue | • 81255BX | • Grey half |

Rocker and Toggle Switch Capabilities

Single Pole (SP)

A switch that opens, closes or changes connection of a single conductor in an electrical circuit.

Double Pole (DP)

A switch that opens, closes or changes connection of two conductors in an electrical circuit.

Single Throw (ST)

A switch that opens, closes or completes a circuit at only one of the extreme positions of its actuator.

Double Throw (DT)

A switch that opens, closes or completes a circuit at both extreme positions of its actuator.

Note: "Pole" should not be confused with "Terminal". The DPST switch, for example has four terminals however is a Double Pole (DP) and not a Four Pole (4P) switch.

SPST On/Off

Switch controls a single wire circuit.



SPDT On/On and SPDT On/Off/On

Switch controls two single wire circuits, permitting only one circuit to be energised at a time.



DPST On/Off

Switch controls two single wire circuits, permitting only one circuit to be energised at a time.

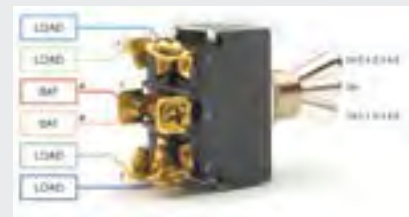

DPDT On/On and DPDT On/Off/On

Switch controls two circuits, permitting only two circuits to be energised at a time.

Rocker Switch Mounting Accessories

Bezels for Mounting Switches Side by Side

For snap-in mounting of any regular size switch such as 58312 and 58328 series. Bezels can be arranged in a parallel array of any length.

Bezels themselves can snap into a panel, or be mounted with the Bracket Mounting Kit.



Part Numbers

| | | | |
|-----------|--------|----------|--------|
| 98628BX | Blank | 82159-3B | End |
| 82159-2BX | Centre | 82159-3B | Single |

Snap-together Bracket Mounting Kit

For installing an array of switches onto a panel, when through mounting isn't possible. Use in conjunction with 82159 bezels.

Holds from 2 to 6 bezels. Snap-together assembly. Kit contains two bracket sections and brass stabilising rods.

Kit brackets engage with bezels. Brass rods snap into brackets to stabilize the unit.



Part Numbers

| | |
|------------|-------|
| 87167-01BP | Boxed |
|------------|-------|

58312 Series - Sealed Rocker Switches with LED Pilot Lights

The 58312 Series Switches feature modern LED technology which gives a wide illumination angle, low power consumption and long service life, meaning no globes to change. IP66 rated.

With silver contacts for superior switching performance, and modern rounded edges and actuators, these matte finish switches fit perfectly into any modern vehicle or machine.



SPST On/Off Dependent LED Rocker Switch

58312-A4BX

The 58312 Series switches feature modern LED technology which gives a wide illumination angle, low power consumption and long service life.

Features

- Dependent operation, on with load
- 3 Blade terminals, silver contacts
- Wide bezel black, snap in mounting
- Weather resistant IP66 sealed
- Fits panel 2.4mm – 4.7mm
- Panel hole: W 21.1mm, H 36.8mm

Specifications

- Voltage 12V
- Amperage 25A@12V
- Dimensions H 44 x D 41 x W 25

Part Numbers

- 58312-A4BX Amber
- 58312-C4BX Clear
- 58312-G4BX Green
- 58312-R4BX Red



Illumination

Dependent vs Independent

Dependent illumination means the lamp in the switch is powered by the load. Therefore, when the switch is off, the lamp is off. When the switch is on, the lamp is illuminated.

This makes it easy to see when the load is active. These switches are also available as On/On and On/Off/On with dual dependent illumination.



Independent + Dependent Illumination

Independent illumination means that a separate electrical signal or switch powers the lamp, regardless of what function the switch is performing at any one time.

For example, the independent lamp might be wired to the dash lights of a vehicle to make the switch visible in the dark. Or it could be used as a driving light switch with the independent lamp signaling when the headlights are active.

The independent + dependent switches enable a pilot light to be illuminated and an additional lamp to be illuminated when the switch is actuated.



SPDT On/Off/On Dependent LED Rocker Switch

58312-AGBX

The 58312 Series switches feature modern LED technology which gives a wide illumination angle, low power consumption and long service life.

Features

- Dependent LED's x 2, On with Load
- 4 Blade terminals, silver contacts
- Wide bezel black, snap in mounting
- Weather resistant IP66 sealed
- Fits panel 2.4mm – 4.7mm
- Panel hole: W 21.1mm, H 36.8mm

Specifications

- Voltage 12V
- Amperage 25A@12V
- Dimensions H 44 x D 41 x W 25

Part Numbers

- 58312-AGBX Amber/Green

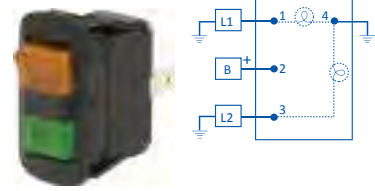

SPST On/Off Dependent Pilot Rocker Switch

58328-13BX

Rocker Switches are manufactured in many different variations to handle most vehicle and equipment applications and are usually classified by the number of poles and throws to identify their basic operation.

Features

- Dependent pilot On with load
- Black actuator illuminated
- 3 Blade terminals, silver contacts
- Wide bezel, snap in mounting
- Range of colour options
- Fits panel 2.36mm – 4.73mm
- Panel hole: W 21.1mm, H 36.8mm

Specifications

- Voltage 12V or 24V
- Amperage 25A@12V
- Dimensions H 43 x D 41 x W 24
- Configuration SPST
- Modes On/Off

Part Numbers

- 58328-04BX Red 12V
- 58328-11BX Green 12V
- 58328-12BX Clear 12V
- 58328-13BX Amber 12V
- 58328-55BX Blue 12V
- 58328-58BX Red 24V
- 58328-62BX Amber 24V



58326 Series - Sealed Rocker Switches with Incandescent Pilot Lights

The Incandescent Paddle Series Rocker Switches feature imprinted automotive symbols on some models.

With silver contacts for superior switching performance, these matte finish switches fit perfectly into any modern or classic vehicle or machine.



SPST On/Off Illuminated Symbol Rocker

58326-01BRX

Features

- Independent illumination, Term 7 & 8
- Sealed, blade terminals, silver contacts
- Nylon wide bezel, snap in mounting
- Supplied with neoprene panel seal
- Fits panels 2.35mm – 4.73mm
- Panel hole: W 21.1mm, H 36.8mm

Specifications

- Voltage 12V
- Amperage 25A@12V
- Dimensions H 49 x D 39 x W 24
- Configuration SPST
- Modes On/Off

Part Numbers

- 58326-01BRX Red Blank

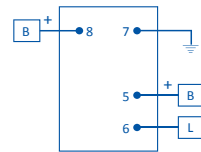

DPDT Off/On/Mom On Illuminated Symbol

58326-11BX

Features

- Independent illumination, Term 7 & 8
- SPST Off/On Term 2 & 3
- SPDT Mom On Term 5 & 6
- Sealed, blade terminals, silver contacts
- Nylon wide bezel, snap in mounting
- Supplied with neoprene panel seal
- Fits panels 2.35mm – 4.73mm
- Panel hole: W 21.1mm, H 36.8mm

Specifications

- Voltage 12V
- Amperage 25A@12V
- Dimensions H 49 x D 39 x W 24
- Configuration SPST
- Modes Off/On/Mom On

Part Numbers

- 58326-11BX White Warning

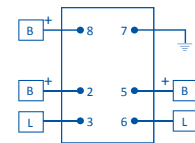

DPDT On/On/On Illuminated Symbol Rocker

58326-29BX

Features

- Independent illumination, Term 7 & 8
- On 1&2, 4&5> On 2&3, 4&5> On 2&3, 5&6
- Sealed, blade terminals, silver contacts
- Nylon wide bezel, snap in mounting
- Supplied with neoprene panel seal
- Fits panels 2.35mm – 4.73mm
- Panel hole: W 21.1mm, H 36.8mm

Specifications

- Voltage 12V
- Amperage 25A@12V
- Dimensions H 49 x D 39 x W 24
- Configuration DPTT
- Modes On/On/On

Part Numbers

- 58326-29BX White Fan

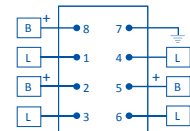

58311 Series - IP66 Sealed Weather Resistant Rocker Switches

The 58311 Series Switches feature silver contacts for superior switching performance, and modern rounded edges and actuators, these matte finish switches fit perfectly into any modern vehicle or machine.

They are also IP66 rated.



SPST Sealed Blank Rocker Switch

58311-02BX

Features

- 2 Blade terminals, silver contacts
- Wide bezel black, snap in mounting
- Weather resistant IP66 sealed
- Fits panels 2.35mm - 4.73mm
- Panel hole: W 21.1mm, H 36.8mm

Specifications

- Voltage 12/24V Dual voltage
- Amperage 25A@12V, 12A@24V
- Dimensions H 44 x D 41 x W 25

Part Numbers

- 58311-02BX Off/Mom On

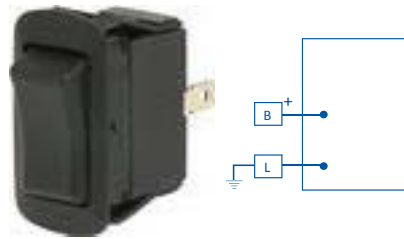

DPST Sealed Blank Rocker Switch

58311-08B

Features

- 6 Blade terminals, silver contacts
- Wide bezel black, snap in mounting
- Weather resistant IP66 sealed
- Polarity reversing
- Fits panels 2.35mm - 4.73mm
- Panel hole: W 21.1mm, H 36.8mm

Specifications

- Voltage 12/24V Dual voltage
- Amperage 25A@12V, 12A@24V
- Dimensions H 44 x D 41 x W 25

Part Numbers

- 58311-08B On/On

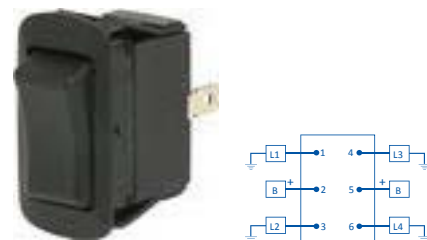

SPST Non-Illuminated Blank Rocker Switch

58027-01BX

Features

- 2 Blade terminals, silver contacts
- Narrow black bezel, snap in mounting
- Fits panels 2.35mm - 4.73mm
- Panel hole: W 21.1mm, H 36.8mm

Specifications

- Voltage 12/24V Dual voltage
- Amperage 25A@12V, 12A@24V
- Dimensions H 43 x D 41 x W 24

Part Numbers

- 58027-01BX On/Off
- 58027-02BX Off/Mom On

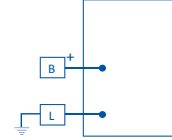

SPDT Non-Illuminated Blank Rocker Switch

58027-03BX

Features

- 3 Blade terminals, silver contacts
- Narrow black bezel, snap in mounting
- Fits panels 2.35mm - 4.73mm
- Panel hole: W 21.1mm, H 36.8mm

Specifications

- Voltage 12/24V Dual voltage
- Amperage 25A@12V, 12A@24V
- Dimensions H 43 x D 41 x W 24

Part Numbers

- 58027-03BX On/Off/On
- 58027-04BX Mom On/Off/Mom On

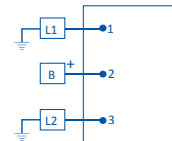

DPDT On/Off/On Non-Illuminated Blank Rocker

58027-07BX

Features

- 6 Blade terminals, silver contacts
- Narrow black bezel, snap in mounting
- Fits panels 2.35mm - 4.73mm
- Panel hole: W 21.1mm, H 36.8mm

Specifications

- Voltage 12/24V Dual voltage
- Amperage 25A@12V, 12A@24V
- Dimensions H 43 x D 41 x W 24

Part Numbers

- 58027-07BX On/Off/On

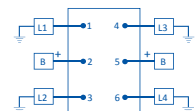

DPDT Mom On/Off/Mom On Reversing Rocker

58027-11BX

Features

- Polarity reversing
- 6 Blade terminals, silver contacts
- Narrow black bezel, snap in mounting
- Fits panels 2.35mm - 4.73mm
- Panel hole: W 21.1mm, H 36.8mm

Specifications

- Voltage 12/24V Dual voltage
- Amperage 25A@12V, 12A@24V
- Dimensions H 43 x D 41 x W 24

Part Numbers

- 58027-11BX Mom On/Off/Mom On

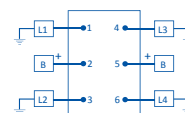

Blank Rocker and Toggle Switch 12V, 24V, 36V Ratings

Generally, Cole Hersee heavy duty 12V non-illuminated* Rocker and Toggle Switches can be used at higher voltage but lower current.

Example: By calculation, 25A 12V switch will derate to 8.3A at 36V, or 12.5A at 24V. This calculated de-rating gives a conservative result. 25A at 12V Toggle Switches* can actually be used at 15A at 24V, and 10A at 36V.

*Exception: This does not apply to Illuminated switches. The pilot light must only be supplied with the stated voltage. Do not derate any illuminated switches.



SPST On/Off Sealed Marine Blank Rocker Switch

M58031-01BX

Features

- Water resistant, IP66 rating, UL 1500
- Supplied with neoprene panel seal
- 2 Blade terminals, silver contacts
- Wide black bezel, snap in mounting
- Fits panels 2.35mm - 4.73mm
- Panel hole: W 21.1mm, H 36.8mm

Specifications

- Voltage 12/24V Dual voltage
- Amperage 20A@12V, 10A@24V
- Dimensions H 49 x D 39 x W 24

Part Numbers

- M58031-01BX On/Off

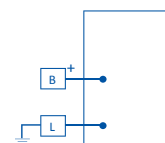

SPST Off/Mom On Sealed Marine Blank Rocker

M58031-07BX

Features

- Water resistant, IP66 rating, UL 1500
- Supplied with neoprene panel seal
- 2 Blade terminals, silver contacts
- Wide black bezel, snap in mounting
- Fits panels 2.35mm - 4.73mm
- Panel hole: W 21.1mm, H 36.8mm

Specifications

- Voltage 12/24V Dual voltage
- Amperage 20A@12V, 10A@24V
- Dimensions H 49 x D 39 x W 24

Part Numbers

- M58031-07BX Off/Mom On

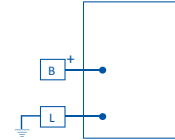

SPDT On/Off/On Sealed Marine Blank Rocker

M58031-02BX

Features

- Water resistant, IP66 rating, UL 1500
- Supplied with neoprene panel seal
- 3 Blade terminals, silver contacts
- Wide black bezel, snap in mounting
- Fits panels 2.35mm - 4.73mm
- Panel hole: W 21.1mm, H 36.8mm

Specifications

- Voltage 12/24V Dual voltage
- Amperage 20A@12V, 10A@24V
- Dimensions H 49 x D 39 x W 24

Part Numbers

- M58031-02BX On/Off/On

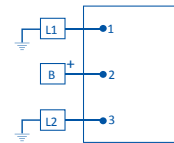

DPST On/Off Sealed Marine Blank Rocker

M58031-04BX

Features

- Water resistant, IP66 rating, UL 1500
- Supplied with neoprene panel seal
- 4 Blade terminals, silver contacts
- Wide black bezel, snap in mounting
- Fits panels 2.35mm - 4.73mm
- Panel hole: W 21.1mm, H 36.8mm

Specifications

- Voltage 12/24V Dual voltage
- Amperage 20A@12V, 10A@24V
- Dimensions H 49 x D 39 x W 24

Part Numbers

- M58031-04BX On/Off

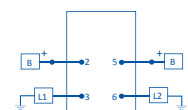

SPST On/Off Dependent Pilot Rocker Switch

58327-01BX

Features

- Dependent pilot On with load
- Black actuator illuminated
- 3 Blade terminals, silver contacts
- Wide bezel, snap in mounting
- Fits panel 2.36mm – 4.73mm
- Panel hole: W 21.1mm, H 36.8mm

Specifications

- Voltage 12V
- Amperage 25A@12V
- Dimensions H 43 x D 38 x W 25
- Configuration SPST
- Modes On/Off

Part Numbers

- 58327-01BX Boxed

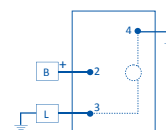

SPST On/Off Locking Actuator Rocker Switch

58336BX

This Rocker Switch automatically locks the actuator into the Off position to help prevent accidental actuation. And must be slid to allow the actuator to be moved to the On position.

Features

- Locking actuator, slide release
- Orange Lock on each operation
- 2 Blade terminals, silver contacts
- Fits panels 2.35mm to 4.73mm
- Panel hole: W 21.1mm, H 36.8mm

Specifications

- Voltage 12V or 24V
- Amperage 25A@12V
- Dimensions H 43 x D 38 x W 25
- Configuration SPST
- Modes On/Off

Part Numbers

- 58336BX Boxed

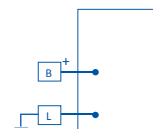

SPST On/Off Illuminated Red Rocker Switch

54012BX

Features

- 3 Blade terminals, silver contacts
- Narrow body, snap in mounting
- Fits panels thickness 1.35 - 5.15mm
- Panel hole W 14mm, H 28.6mm

Specifications

- Voltage 12V
- Amperage 10A@12V
- Dimensions H 31 x D 35 x W 17

Part Numbers

- 54012BX Boxed

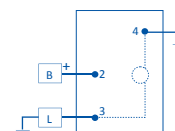

Rocker Switch Mounting End Section

82159-1BX

Features

- Rocker switch end panel
- Hole height 48.3mm, W 26.2mm for each section
- Accepts wide body rockers 58328, 58027, 58326, 58312 & 58311 series

Specifications

- Dimensions H 59 x D 31 x W 31

Part Numbers

- 82159-1BX Boxed

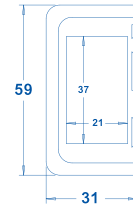

Rocker Switch Mounting Centre Section

82159-2BX

Features

- Rocker switch centre panel
- Hole height 48.3mm, W 26.2mm for each section
- Accepts wide body rockers 58328, 58027, 58326, 58312 & 58311 series

Specifications

- Dimensions H 59 x D 31 x W 27

Part Numbers

- 82159-2BX Boxed

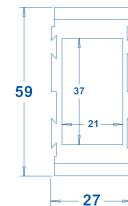

Rocker Switch Mounting Independent Bezel

82159-3B

Features

- Rocker switch independent bezel
- Hole height 48.3mm, W 25mm
- Accepts wide body rockers 58328, 58027, 58326, 58312 & 58311 series

Specifications

- Dimensions H 48.3 x D 31 x W 25

Part Numbers

- 82159-3B Boxed



Rocker Switch Mounting Blank Insert Cover

98628BX

Features

- Rocker blank insert
- Use with rocker switch mounting brackets 82159-1BX and 82159-2BX

Specifications

- Dimensions H 48.3 x D 31 x W 25

Part Numbers

- 98628BX Boxed



SPST On/Off Blade Terminals Toggle Switch

55014BX

Features

- 2 Blade terminals, silver contacts
- Stem: thread 15/32-32, L 12mm, D 12mm
- Panel thickness: 6.35mm, Handle: 17mm

Specifications

- Voltage 12/24V Dual voltage
- Amperage 25A@12V, 12A@24V
- Dimensions H 29 x D 60 x W 16

Part Numbers

- 55014BX Boxed

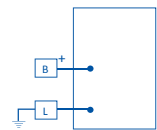

SPST On/Off Screw Terminals Toggle Switch

5582BX

Features

- 2 Screw terminals, silver contacts
- Stem: thread 15/32-32, L 12mm, D 12mm
- Panel thickness: 6.35mm, Handle: 17mm

Specifications

- Voltage 12/24V Dual voltage
- Amperage 25A@12V, 12A@24V
- Dimensions H 29 x D 55 x W 16

Part Numbers

- 5582BX Boxed

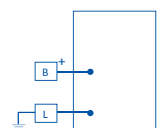

SPST On/Off Sealed Leads Toggle Switch

5582-10BX

Features

- O-ring in stem, silver contact
- Pre-wired, PVC coated housing
- Stem: thread 15/32-32, L 12mm, D 12mm
- Panel thickness: 6.35mm, Handle: 17mm

Specifications

- Voltage 12/24V Dual voltage
- Amperage 25A@12V, 12A@24V
- Dimensions H 29 x D 55 x W 16

Part Numbers

- 5582-10BX Boxed

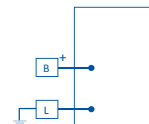

SPDT On/On Screw Terminals Toggle Switch

5584BX

Features

- 3 Screw terminals, silver contacts
- Stem: thread 15/32-32, L 12mm, D 12mm
- Panel thickness: 6.35mm, Handle: 17mm

Specifications

- Voltage 12/24V Dual voltage
- Amperage 25A@12V, 12A@24V
- Dimensions H 29 x D 53 x W 16

Part Numbers

- 5584BX Boxed

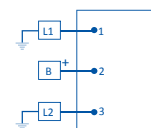

DPDT On/Off/On Screw Terminals Toggle Switch

5592BX

Features

- 6 Screw terminals, silver contacts
- Stem: thread 15/32-32, L 12mm, D 12mm
- Panel thickness: 6.35mm, Handle: 17mm

Specifications

- Voltage 12/24V Dual voltage
- Amperage 25A@12V, 12A@24V
- Dimensions H 33 x D 48 x W 19

Part Numbers

- 5592BX Boxed

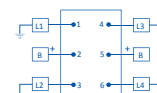

SPDT On/Off/On Blade Screw Toggle Switch

5586BX

Features

- 3 Screw terminals, silver contacts
- Stem: thread 15/32-32, L 12mm, D 12mm
- Panel thickness: 6.35mm, Handle: 17mm

Specifications

- Voltage 12/24V Dual voltage
- Amperage 25A@12V, 12A@24V
- Dimensions H 29 x D55 x W 16

Part Numbers

- 5586BX Boxed

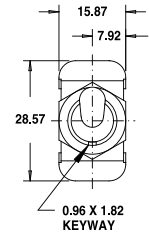

IP68 SPDT On/Off/On Sealed Leads Toggle Switch

M55036BX

Features

- O-ring in stem, silver contact
- Pre-wired, PVC coated housing
- Stem: thread 15/32-32, L 12mm, D 12mm
- Panel thickness: 6.35mm, Handle: 17mm

Specifications

- Voltage 12/24V Dual voltage
- Amperage 25A@12V, 12A@24V
- Dimensions H 29 x D 55 x W 16

Part Numbers

- M55036BX Boxed

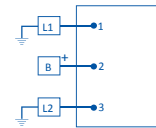

SPST On/Off Blade Terminals Mini Toggle

M586BX

Features

- 2 Blade terminals
- Stem: thread 15/32-32, L 12mm, D 12mm
- Panel thickness: 6.35mm, Handle: 17mm

Specifications

- Voltage 12/24V Dual voltage
- Amperage 25A@12V, 12A@24V
- Dimensions H 32 x D 41 x W 13

Part Numbers

- M586BX Boxed

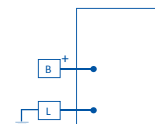

SPST Off/Mom On Screw Terminals Toggle

55020BX

Features

- 2 Screw terminals, silver contacts
- Stem: thread 15/32-32, L 12mm, D 12mm
- Panel thickness: 6.35mm, Handle: 17mm

Specifications

- Voltage 12/24V Dual voltage
- Amperage 25A@12V, 12A@24V
- Dimensions H 28 x D 41 x W 16

Part Numbers

- 55020BX Boxed



SPDT Mom On/Off/Mom On Screw Terminals

55021BX

Features

- 2 Screw terminals, silver contacts
- Stem: thread 15/32-32, L 12mm, D 12mm
- Panel thickness: 6.35mm, Handle: 17mm

Specifications

- Voltage 12/24V Dual voltage
- Amperage 25A@12V, 12A@24V
- Dimensions H 34 x D 55 x W 19

Part Numbers

- 55021BX Boxed



SPDT Mom On/Off/Mom On Screw Terminals

55021-07BX

Features

- O-ring in stem, silver contact
- Pre-wired, PVC coated housing
- Stem: thread 15/32-32, L 12mm, D 12mm
- Panel thickness: 6.35mm, Handle: 17mm

Specifications

- Voltage 12/24V Dual voltage
- Amperage 25A@12V, 12A@24V
- Dimensions H 34 x D 55 x W 19

Part Numbers

- 55021-07BX Boxed



SPST On/Off Blade Terminals Long Handle

55055BX

Features

- 2 Blade terminals, silver contacts
- Stem: thread 15/32-32, L 12mm, D 12mm
- Panel thickness: 6.35mm, Handle: 38mm

Specifications

- Voltage 12/24V Dual voltage
- Amperage 25A@12V, 12A@24V
- Dimensions H 28 x D 94 x W 16

Part Numbers

- 55055BX Boxed



DPDT On/Off/On Blade Terminals Long Handle

55057BX

Features

- 6 Blade terminals, silver contacts
- Stem: thread 15/32-32, L 12mm, D 12mm
- Panel thickness: 6.35mm, Handle: 38mm

Specifications

- Voltage 12/24V Dual voltage
- Amperage 25A@12V, 12A@24V
- Dimensions H 34 x D 94 x W 19

Part Numbers

- 55057BX Boxed



SPST On/Off Blade Terminals Illuminated Red

M54111-01BX

Features

- Clear Off, illuminates red On
- 4 Blade terminals, silver contacts
- Stem: thread 15/32-32, L 9mm, D 12mm
- Panel thickness: 6.35mm, Handle: 17mm

Specifications

- Voltage 12V
- Amperage 25A@12V
- Dimensions H 35 x D 56 x W 16

Part Numbers

- M54111-01BX Boxed



Independent Illumination

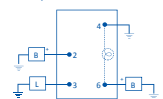

Dependent Illumination

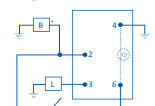

DPDT On/Off/On Blade Long Handle Head Light

55064BX

Features

- Bridged 4 circuit, headlamp switch
- 6 Blade terminals, silver contacts
- Stem: thread 15/32-32, L 12mm, D 12mm
- Panel thickness: 6.35mm, Handle: 38mm

Specifications

- Voltage 12/24V Dual voltage
- Amperage 25A@12V, 12A@24V
- Dimensions H 34 x D 94 x W 19

Part Numbers

- 55064BX Boxed

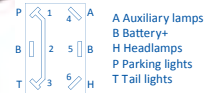

SPDT On/Off/On Blade Terminals Paddle Toggle

59024-13BX

Features

- Paddle handle (nylon), rep 'Freightliner'
- 3 Blade terminals, silver contacts
- Stem: thread 15/32-32, L 12mm, D 12mm
- Panel thickness: 6.35mm, Handle: 25mm

Specifications

- Voltage 12/24V Dual voltage
- Amperage 25A@12V, 12A@24V
- Dimensions H 33 x D 67 x W 19

Part Numbers

- 59024-13BX Boxed

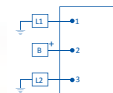

DPDT On/On Blade Terminals Toggle Switch

55018BX

Features

- 6 Blade terminals, silver contacts
- Stem: thread 15/32-32, L 12mm, D 12mm
- Panel thickness: 6.35mm, Handle: 17mm

Specifications

- Voltage 12/24V Dual voltage
- Amperage 25A@12V, 12A@24V
- Dimensions H 34 x D 60 x W 19

Part Numbers

- 55018BX Boxed

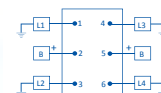

DPDT On/Off/On Blade Terminals Toggle Switch

55019B

Features

- 6 Blade terminals, silver contacts
- Stem: thread 15/32-32, L 12mm, D 12mm
- Panel thickness: 6.35mm, Handle: 17mm

Specifications

- Voltage 12/24V Dual voltage
- Amperage 25A@12V, 12A@24V
- Dimensions H 34 x D 60 x W 19

Part Numbers

- 55019B Boxed

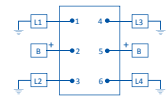

DPDT Mom On/Off/On Blade Terminals Reversing

55081B

Features

- Reversing polarity
- 6 Blade terminals, silver contacts
- Stem: thread 15/32-32, L 12mm, D 12mm
- Panel thickness: 6.35mm, Handle: 17mm

Specifications

- Voltage 12/24V Dual voltage
- Amperage 25A@12V, 12A@24V
- Dimensions H 28 x D 58 x W 19

Part Numbers

- 55081B Boxed

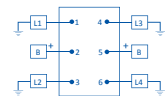

DPDT Mom On/Off/Mom On Screw Reversing

55054BX

Features

- Reversing polarity
- 6 Screw terminals, silver contacts
- Stem: thread 15/32-32, L 12mm, D 12mm
- Panel thickness: 6.35mm, Handle: 17mm

Specifications

- Voltage 12/24V Dual voltage
- Amperage 25A@12V, 12A@24V
- Dimensions H 34 x D 58 x W 19

Part Numbers

- 55054BX Boxed

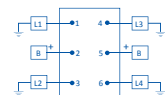

DPDT Mom On/Off/Mom On Blade Reversing

55065-03BX

Features

- Reversing polarity
- 6 Blade terminals, silver contacts
- Stem: thread 15/32-32, L 12mm, D 12mm
- Panel thickness: 6.35mm, Handle: 17mm

Specifications

- Voltage 12/24V Dual voltage
- Amperage 25A@12V, 12A@24V
- Dimensions H 34 x D 58 x W 19

Part Numbers

- 55065-03BX Boxed

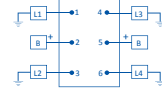

DPDT Mom On/Off/Mom On Blade Reversing

55065-02BX

Features

- Reversing polarity, long handle
- 6 Blade terminals, silver contacts
- Stem: thread 15/32-32, L 12mm, D 12mm
- Panel thickness: 6.35mm, Handle: 38mm

Specifications

- Voltage 12/24V Dual voltage
- Amperage 25A@12V, 12A@24V
- Dimensions H 34 x D 58 x W 19

Part Numbers

- 55065-02BX Boxed

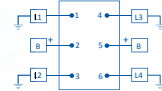

DPDT Mom On/Off/Mom On Bridged Reversing

55046BX

This switch is used for changing direction of permanent magnet electric motors: fans, booms, conveyors etc.

Features

- 4 Blade terminals, silver contacts

Specifications

- Voltage 12/24V Dual voltage
- Amperage 25A@12V, 12A@24V
- Dimensions H 34 x D 69 x W 19

Part Numbers

- 55046BX Boxed

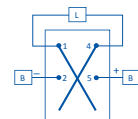

Toggle Switch Silicone Sealing Boots

81264BX

Features

- Highly-durable silicone rubber
- O-ring seal with the panel
- Silicone rubber, up to 17.5mm handle
- Suits thread 15/32-32, Screw on to fit

Part Numbers

- 81264BX Grey
- 81264-01BX Black
- 81264-02BX Blue

Part Numbers

- 81264-05BX Red
- 81264-07BX Yellow
- 81255BX Grey half



Toggle Switch Security Cover Guard

82468BX

Features

- For security of switch operation
- Spring-loaded snap action cover
- Stops accidental operation
- Rugged red melamine cover
- Suit D 12mm, Handle 18mm

Specifications

- Dimensions H 47 x D 27 x W 18

Part Numbers

- 82468BX Boxed

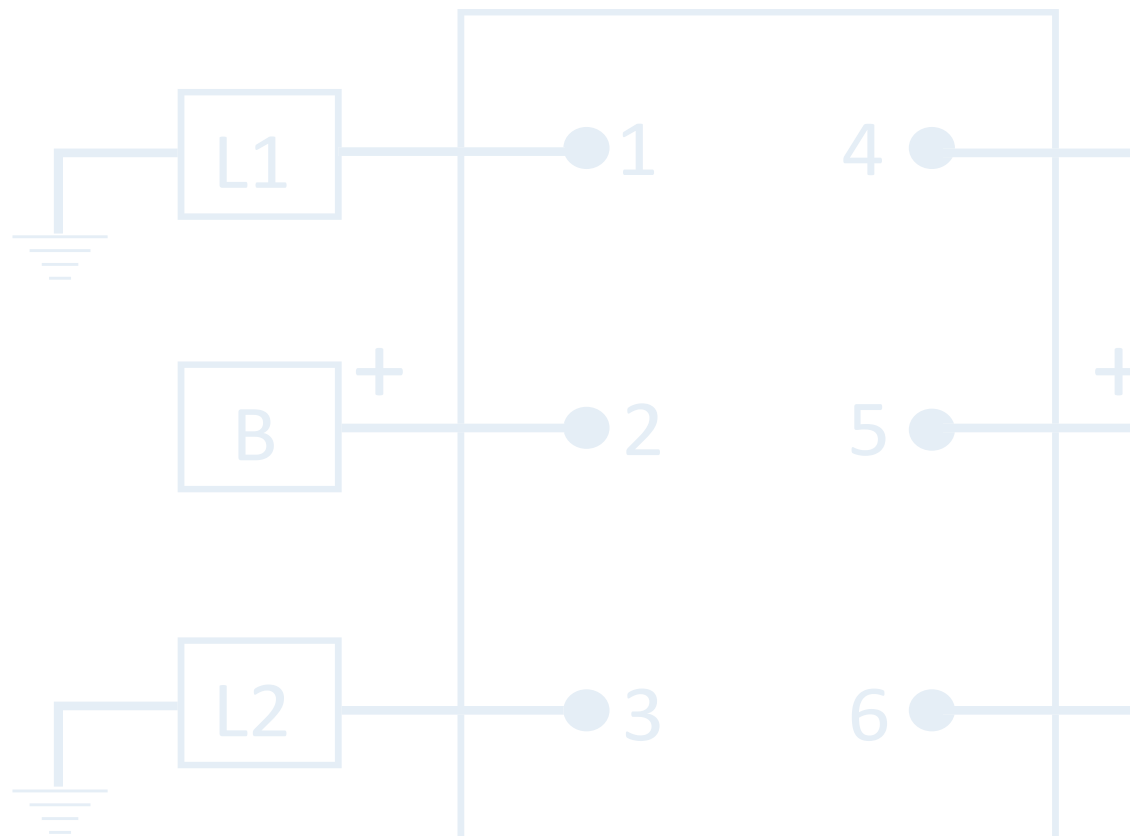



Push Button Switches

Push Button Switches (sometimes referred to as Momentary Switches) are most commonly used for Off/Mom On ignition type applications.

Cole Hersee Push Button Switches are available in die-cast alloy or brass housing with most featuring chrome plated button and face nut or rubber capping. Some models feature a PVC coated body to help seal against moisture and dirt.



PUSH BUTTON SWITCHES

SPST Off/Mom On START Push Button Switch

90047BX

Features

- 2 Screw terminals, silver contacts
- 'ENGINE START' imprint (black)
- 'ENGINE STOP' imprint (red)
- Embossed in white on black/red
- Impact resistant, repels water and oil
- Mounting hole 21mm
- Suits panel thickness 1mm to 2.5mm

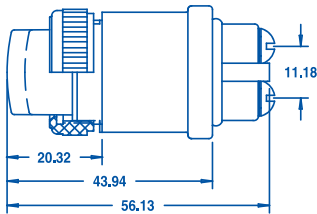

Specifications

- Voltage 6V-36V Multivoltage
- Amperage 35A@12V, 20A@24V
- Dimensions H 56 x Ø 29
- Configuration SPST
- Modes Off/Mom On

Part Numbers

- 90047BX Boxed (start)
- 90048BX Boxed (stop)



SPST Off/Mom On Screw Push Button Switch

90030BX

Features

- Spring return to Off
- 2 Screw terminals, silver contacts
- Protective weather/dustproof cap
- Mounting stem 5/8" - 32, Length 16mm
- Suits panel thickness 6.35mm-15.87mm

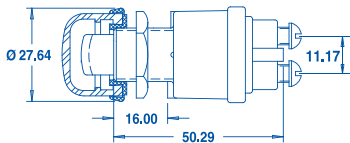

Specifications

- Voltage 6V-36V Multivoltage
- Amperage 35A@12V, 20A@24V
- Dimensions H 60 x Ø 28
- Configuration SPST
- Modes Off/Mom On

Part Numbers

- 90030BX Boxed



SPST On/Mom Off Sealed Push Button Switch

90043BX

Features

- Spring return to On
- Normally On, 2 blade terminals
- 2 Screw terminals (with lock washers)
- Mounting stem 5/8"-32, Length 22.3mm
- Suits panel thickness 12.7mm

Specifications

- Voltage 6V-36V Multivoltage
- Amperage 10A@12V, 5A@24V
- Dimensions H 33 x D 62 x W 29

Part Numbers

- 90043BX Boxed

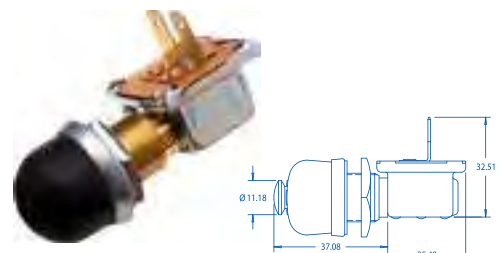

SPST On/Mom Off Sealed Push Button Switch

90043-07BX

Features

- Spring return to On
- Normally On, steel plunger
- Pre-wired PVC coated body
- Mounting stem 5/8"-32, Length 16mm
- Suits panel thickness 12.7mm

Specifications

- Voltage 6V-36V Multivoltage
- Amperage 20A@12V, 10A@24V
- Dimensions H 33 x D 62 x W 29

Part Numbers

- 90043-07BX Boxed



SPST Off/Mom On Sealed Push Button Switch

M608BX

Features

- Spring return to Off
- Pre-wired PVC coated housing
- Copper alloy contacts, brass body
- Mounting stem 5/8"-32, L 24mm
- Suits panel thickness 12.70mm

Specifications

- Voltage 6V-36V Multivoltage
- Amperage 10A@12V, 5A@24V
- Dimensions H 33 x D 62 x W 29

Part Numbers

- M608BX Boxed

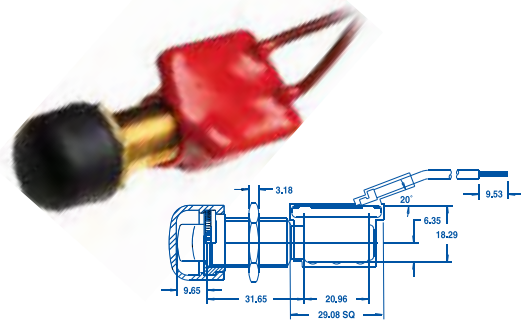

SPST Off/On Sealed Push Button Switch

M606BX

Features

- Pre-wired PVC coated housing
- Chrome plated brass knob and face nut
- Copper alloy contacts, dia 22.3mm
- Suits panel thickness up to 15.87mm

Specifications

- Voltage 6V-36V Multivoltage
- Amperage 10A@12V, 5A@24V
- Dimensions H 82 x D 22 x W 32

Part Numbers

- M606BX Boxed



SPST Off/On Screw Push Pull Button Switch

M628BX

Features

- 2 Screw terminals, Brass Push Pull
- Copper alloy contacts, dia 22.3mm
- Chrome plated brass knob and face nut
- Suits panel thickness up to 15.87mm

Specifications

- Voltage 6V-36V Multivoltage
- Amperage 10A@12V, 5A@24V
- Dimensions H 68 x D 22 x W 31

Part Numbers

- M628BX Boxed



SPST On/Mom Off Screw Push Button Switch

9115BX

Features

- Spring return to On
- Normally On, chrome button
- 2 screw terminals (with lock washers)
- Stem 5/8"-32, L 22.3mm, dia 16mm
- Suits panel thickness 12.7mm

Specifications

- Voltage 6V-36V Multivoltage
- Amperage 10A@12V, 5A@24V
- Dimensions H 33 x D 51 x W 23

Part Numbers

- 9115BX Boxed

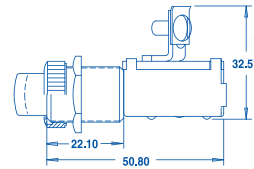

SPST Off/Mom On Screw Push Button Switch

9095BX

Features

- Spring return to Off
- 2 screw terminals, silver contacts
- Mounting stem 5/8"-32, Length 16mm
- Suits panel thickness 6.35mm -16mm

Specifications

- Voltage 6V-36V Multivoltage
- Amperage 35A@12V, 20A@24V
- Dimensions H 58 x Ø 28

Part Numbers

- 9095BX Boxed

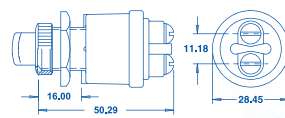

SPST Off/Mom On Push Button Switch

96101BX

Features

- Spring return to Off
- 2 screw terminals
- Copper alloy contacts
- Black button, flange mount

Specifications

- Voltage 6V-36V Multivoltage
- Amperage 10A@12V, 5A@24V
- Dimensions H 56 x D 26 x W 30

Part Numbers

- 96101BX Boxed

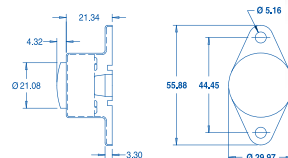



Rotary

Switches

ROTARY SWITCHES

Rotary Switches

Rotary switches are usually used for special purpose applications including headlamp and windscreen wiper operation.

The Cole Hersee range features models which can be used for more common applications.



Windscreen Wiper Washer Off/Park/Lo/Hi

75221-09B

Features

- Without dynamic parking
- 5 blade terminals
- 6A internal circuit breaker
- Push to wash, white imprint
- Mounting stem thread 7/16"-28
- Mounting stem length 9.6mm

Specifications

- Voltage 12/24V Dual voltage
- Amperage 6A@12V, 3A@24V
- Dimensions H 61 x Ø 41

Part Numbers

- 75221-09B Boxed



Windscreen Wiper Washer Off/Park/Lo/Hi

75228-03BX

Features

- For dynamic parking motors, single motor
- 6 blade terminals
- Push to wash, white imprint
- O-ring sealed shaft
- Mounting stem 7/16"-28 thread
- Mounting stem length 11.43mm

Specifications

- Voltage 12/24V Dual voltage
- Amperage 6A@12V, 3A@24V
- Dimensions H 61 x D 41

Part Numbers

- 75228-03BX Boxed

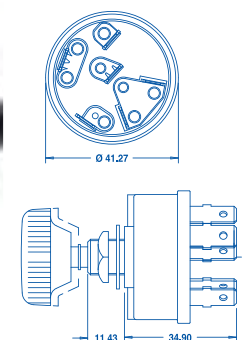

DPDT Reversing Mom On/Off/Mom On

75712-04BX

Heavy duty 50A switch allows forward and reverse motion of a motor without the need for a relay, especially for operation of tarps on trucks.

Features

- 4 Screw terminals, silver contacts
- Mounting stem 1/2"-20
- Terminal screws 10-32 / 9.5mm
- Forward and reverse control of motors

Specifications

- Voltage 6V-36V Multivoltage
- Amperage 50A@12V, 30A@24V
- Dimensions H 69 x Ø 53

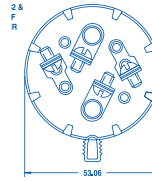

Part Numbers

- 75712-04BX Boxed

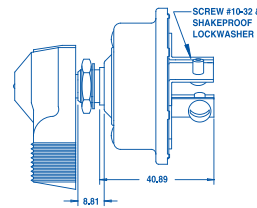
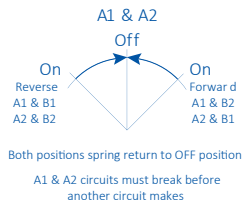

SPST Off/On Round Knob Rotary Switch

72150-01B

Features

- Compact durable nylon body, knob and stem, IP53
- Aluminium hardware, plated brass blade terminals

Specifications

- Voltage 6V-24V Multivoltage
- Amperage 10A@12V, 5A@24V
- Dimensions H 30 x D 52 x W 30

Part Numbers

- 72150-01B Boxed



SPDT Off/On/On Round Knob Rotary Switch

72171-02BX

Features

- Compact durable nylon body, knob and stem, IP53
- Aluminium hardware, plated brass blade terminals

Specifications

- Voltage 6V-24V Multivoltage
- Amperage 10A@12V, 5A@24V
- Dimensions H 30 x D 52 x W 30

Part Numbers

- 72171-02BX Boxed



Windscreen Wiper Washer Electronic 12V

75600-02BX

Features

- Pre-wired single motor control
- Silver contacts, heavy duty
- Mounting stem 7/16"-28 thread, L 11.4mm
- Suits system with or without dynamic park
- Approvals; SAE J1455, J112a, J234

Specifications

- Voltage 12V
- Amperage 6A@12V
- Dimensions H 47 x D 56 x W 56

Part Numbers

- 75600-02BX Boxed

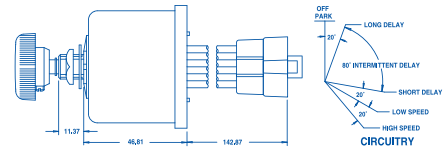

Windscreen Wiper Washer Electronic 24V

75602-04BX

Features

- Single motor control
- Silver contacts, heavy duty
- Mounting stem 7/16"-28 thread, L 11.4mm
- Suits system with or without dynamic park
- Variable speed intermittent function
- Approvals; SAE J1455, J112a, J234

Specifications

- Voltage 24V
- Amperage 3A@24V
- Dimensions H 47 x D 56 x W 56

Part Numbers

- 75602-04BX Boxed

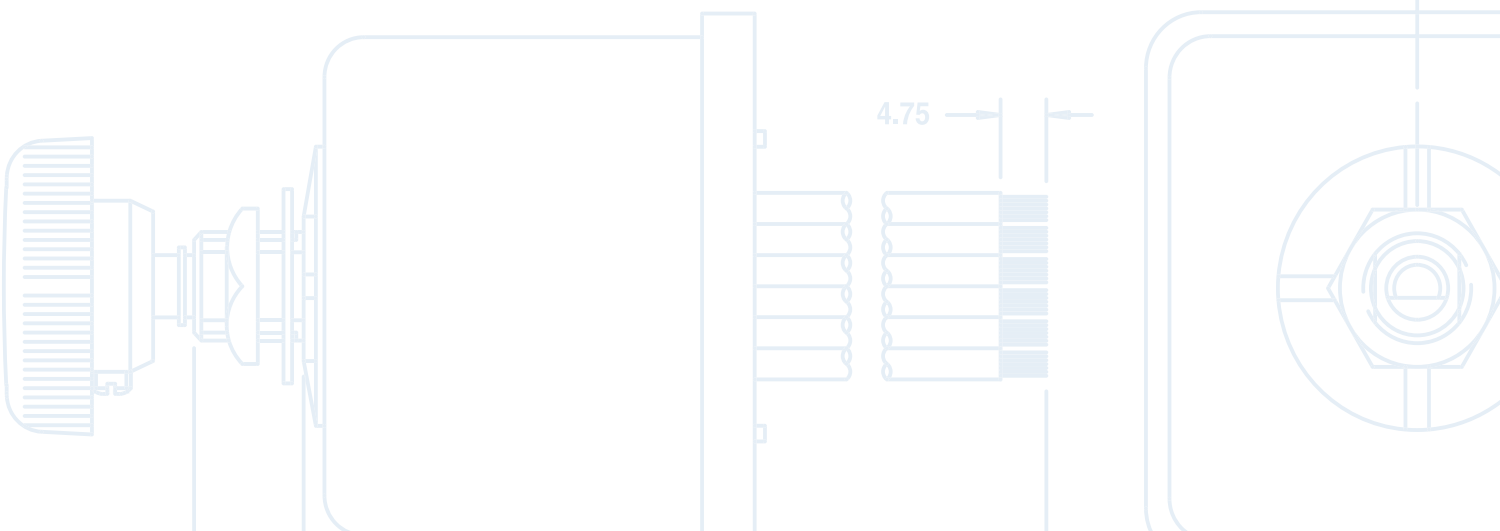
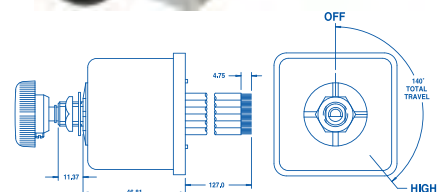

Ignition Switches

Ignition Switches are usually operated by a coded key and tumbler lock, hencol keyed lock or lever. Lever design is available in three different configurations: short, long and military. Ignition Switches are available with coded cylinder locks and keys or hencol non-tumbler locks with compatible keys.

Switches are available with a grounded case design with a separate ground terminal. A grounded case switch must be installed in a metal panel which is part of the vehicle earthing system. In non-grounded panels, select a switch with an earth terminal.

For applications subject to adverse environmental conditions a switch can be furnished with an O-ring seal in the bushing and a gasket seal to protect the terminal insulator. As an added feature Cole Hersee manufactures weather resistant rubber boot and mounting assemblies, and protective caps.

Two, three and four position circuitry is available for battery ignition and magneto switches. Combination circuits include: earth, accessory, lighting, diesel glow plug, and anti-restart options. Standard configurations include spring return from one or two positions.

Screw terminals are equipped with lockwashers to assure efficient connection of circuit wire. Blade terminals are brass, 1/4" wide arranged to accept multi-pole connectors.



Key removable in Off position only, spring return to Ign/Acc position.



Key removable in Off position only, spring return to Ign/Acc position, spring return to Off from Fuel.



Key removable in Off position only, spring return to Ign position.

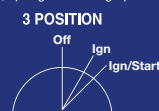

Spring return to Off position from Glow and Glow/Start.

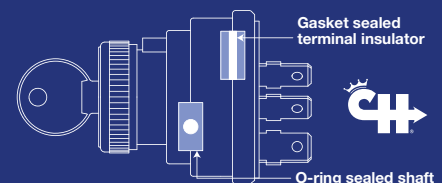

Gasket sealed terminal insulator



O-ring sealed shaft

IGNITION SWITCHES

Anti-Restart 4 Position Sealed Ignition Switch

95060-01BX

This sealed switch from Cole Hersee is constructed from engineered thermoplastic and is OEM quality.

A fully sealed O-ring, ultrasonic welding and integral Deutsch connector, this switch is rated to IP67. Supplied with two matching keys including integrated boots.

Features

- Engineered thermoplastic, OEM quality
- Fully sealed O-ring, ultrasonic welding
- Integral Deutsch connector, IP67
- Selectable switching and key options
- Multiple key codes or keyed alike option
- Supplied with 2 matching keys
- Plastic face nut and nickel plated back nut
- Key removable only in Off position
- Spring return to Ign/Acc position
- Ideal for agricultural, earthmoving and mining

Specifications

- Voltage 6V-24V Multivoltage
- Amperage 10A@12V, 5A@24V
- Dimensions H 72 x Ø 51
- Modes Acc/Off/Ign/Start (anti-restart)
- Application Heavy Duty, Mining, Marine, Key Start



Part Numbers

- 95060-01BX Boxed

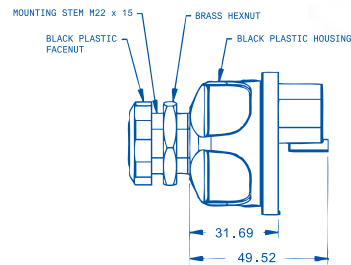
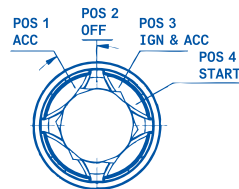

4 Position Heavy Duty Ignition Switch

9579BX

Features

- 4 Screw terminals, bronze contacts
- Heavy duty, coded key actuator
- Key removable in Off position only
- Mounting stem 3/4" – 20 bush
- Panel thickness 1.52mm to 9.52mm

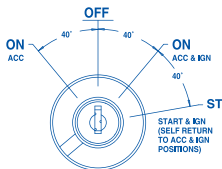

Specifications

- Voltage 12V
- Amperage 10A@12V accessory, 10A@12V ignition, 10A@12V start
- Dimensions H 60 x Ø 37
- Modes Acc/Off/Ign Acc/Ign
- Application Heavy Duty, Mining, Key Start

Part Numbers

- 9579BX Boxed



Marine 3 Position Ignition Off/Ign/Ign Start

M850BX

Features

- Push for choke, coded key actuator
- Impact resistant plastic body
- 3 Screw terminals, nickel silver contacts
- Individual key codes for added security
- Long stem suits panel up to 33mm thick

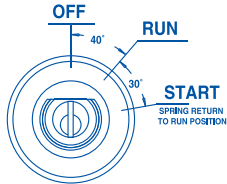

Specifications

- Voltage 6V-36V Multivoltage
- Amperage 15A@6-36V ignition, 20A@6-36V start
- Dimensions H 72 x Ø 38

Part Numbers

- M850BX Boxed



Marine 3 Position Ignition Switch Off/Ign/Ign Start

M550BX

Features

- Heavy duty, 3 brass screw terminals
- Brass case and hardware, coded key actuator
- Key removable in Off position only
- Mounting stem 13/16"-24 bush
- Mounting stem length 30.95mm
- Panel thickness up to 25.40mm

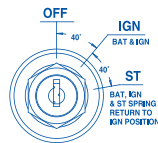
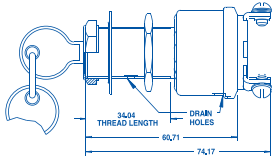

Specifications

- Voltage 12V
- Amperage 10A@12V ignition, 5A@12V start
- Dimensions H 74 x Ø 37

Part Numbers

- M550BX Boxed



Anti-Restart Ignition Switch Off/On/Ign Start

956-3125BX

Features

- 4 Screw terminals, Copper contacts
- O-ring sealed housing, keyed actuator
- Will not restart unless returned to Off position
- Key removable in Off position only
- Mounting stem 1"-24 bush
- Panel thickness 0.76mm to 2.85mm

Specifications

- Voltage 12V
- Amperage 30A@12V accessory, 10A@12V ignition, 10A@12V start
- Dimensions H 65 x Ø 47

Part Numbers

- 956-3125BX Boxed

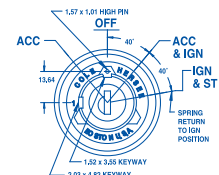
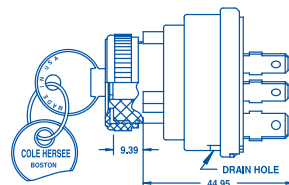

Anti-Restart Ignition Switch Off/Ign/Start

956-3124BX

Features

- 4 Screw terminals, Copper contacts
- O-ring sealed housing, keyed actuator
- Will not restart unless returned to Off position
- Mounting stem 1"-24 bush
- Panel thickness 0.76mm to 2.85mm

Specifications

- Voltage 12V
- Amperage 10A@12V accessory, 10A@12V ignition, 10A@12V start
- Dimensions H 78 x Ø 46

Part Numbers

- 956-3124BX Boxed

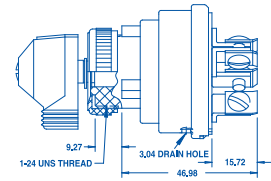
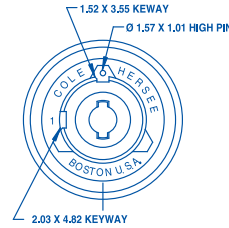

Universal Ignition Switch Off/Ign/Start

95612BX

Features

- 3 Screw terminals, silver contacts
- O-ring sealed housing, lever actuator
- Mounting stem 5/8"-32
- Panel thickness 1.52mm to 6.65mm

Specifications

- Voltage 6V-36V Multivoltage
- Amperage 25A@12V ignition, 20A@12V start
- Dimensions H 81 x Ø 37

Part Numbers

- 95612BX Boxed

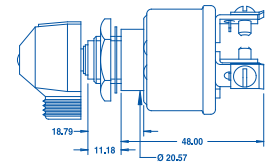
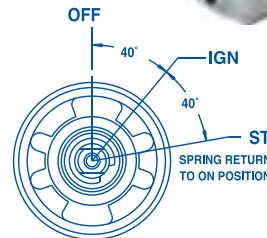

Diesel Ignition Switch 3 Position Glow/Off/Glow Start

95033BX

This heavy duty switch provides a superior pre-heat circuit to energize the glow pins.

Features

- 3 Screw terminals, silver contacts
- O-ring sealed housing, Lever actuator
- Mounting stem 5/8"-32
- Panel thickness 1.52mm to 6.65mm

Specifications

- Voltage 6V-36V Multivoltage
- Amperage 50A@12V ignition, run glow, 5A@12V start
- Dimensions H 81 x Ø 37

Part Numbers

- 95033BX Boxed

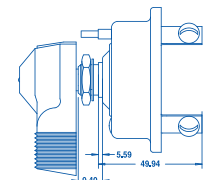
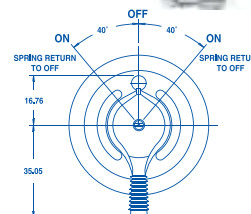



Solenoids



SOLENOIDS

A Solenoid is an electromagnetic relay used in a direct current wiring system between a low current capacity switch and a high current load requirement. In an engine starting system, the ignition switch in the start position may have a rating of 5 amps whilst the starter motor may have a cranking requirement of 200 to 350 amps.

Once energised by the Ignition Switch, the Solenoid coil moves the high current capacity contact to a closed position, thereby energising the starter motor.

When equipment is started, the intermittent starter application is used for only a few seconds during each start. To meet this short term demand, an Intermittent Solenoid is used to carry the high rating of current. However, the Solenoid will overheat and fail, as would the starter motor, if the starter were to run continuously.

For periods up to 15 seconds, it is constructed so it can be energised without overheating and destroying its windings.

Rated much lower, the Continuous Solenoid will not overheat in continuous operation. Used for such applications as accessory circuits and lifts—where there is uninterrupted operation—a Continuous Duty Solenoid is constructed so it can be energised constantly without its windings.

As the demands placed upon vehicle electrical systems continue to increase, the electrical system components must be able to handle higher loads.

Numerous applications require a Solenoid, listed below are just a few:

- Farm equipment
- Emergency vehicles
- Golf carts
- Hoists
- Buses
- Industrial equipment
- Construction equipment
- Tailgates
- Trucks
- Lift trucks
- Tractors

Conservative Electrical Ratings for Solenoids

Intermittent Duty Solenoids

SPST 6–12 volts DC
750 amp make
100 amp break
10 seconds On, 20 minutes Off

Intermittent Duty Solenoids

SPST 6–36 volts DC
120 amp make
65 amp break
10 seconds On, 30 minutes Off

Continuous Duty Solenoids

SPST 24–36 volts DC
85 amp make

Continuous Duty Solenoids: SPDT

35 amp: front studs, normally closed
85 amp: side studs, normally open

Cole Hersee Solenoids

- Intermittent Duty Solenoids: SPST, steel housing, normally open contacts, one circuit: Off/On
- Intermittent Duty Solenoids: SPST, phenolic housing, normally open contacts, one circuit: Off/On
- Intermittent Duty Solenoids: SPST, plasticised steel housing, normally open contacts, one circuit: Off/On
- Continuous Duty Solenoids: SPST, steel housing, normally open contacts, one circuit: Off/On
- Continuous Duty Solenoids: SPST, steel housing, normally closed contacts
- Continuous Duty Solenoids: SPST, steel housing, normally open and closed contacts
- Continuous Duty Solenoids: SPST, plasticised steel housing, normally open contacts, one circuit: Off/On
- Continuous Duty Latching Solenoids: carry only

Please note: some of the above mentioned options may not be shown in this catalogue.

SPST Continuous Duty Solenoid

24059BX

A Solenoid is an electromagnetic relay used in a direct current wiring system between a low current capacity switch and a high current load requirement.

Features

- 4 Stud, Insulated stud earth
- SPST Normally open (one circuit) Off/On
- Copper Stud terminals 5/16"-24
- Insulated Coil terminals 10-32
- Strong plated steel housing
- Plated steel nuts and washers included
- Mounting holes; 8mm x 15mm, 56mm CTC
- Mount with brand cap facing down
- Int. ratings: 10 sec On, 30 min Off

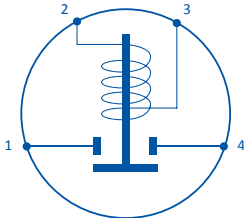

Specifications

- Voltage 12V, 24V, 36V Models
- Dimensions H 60 x D 64 x W 84
- Configuration SPST
- Modes Off/On
- Application Heavy Duty, Mining

Part Numbers 12V, 17.5 ohm

- 24059BX 85A Continuous
750A Make
100A Break

Part Numbers 24V, 71 ohm

- 24063BX 85A Continuous
120A Make
100A Break
- 24144BX 200A Continuous
150A Make
150A Break

Part Numbers 36V, 130 ohm

- 24080BX 85A Continuous
120A Make
65A Break

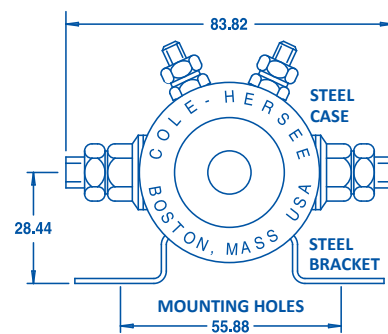

SPST Continuous Duty Insulated Earth PVC Coated

M24117BX

A Solenoid is an electromagnetic relay used in a direct current wiring system between a low current capacity switch and a high current load requirement.

Weatherproof PVC coated housing versions are UL listed and ISO 8846 Marine grade.

Features

- 4 Stud, Insulated stud earth
- SPST Normally open (one circuit) Off/On
- Copper Stud terminals 5/16"-24
- Insulated Coil terminals 10-32
- Strong plated steel housing
- Plated steel nuts and washers included
- Mounting holes; 8mm x 15mm, 56mm CTC
- Mount with brand cap facing down
- Int. ratings: 10 sec On, 30 min Off

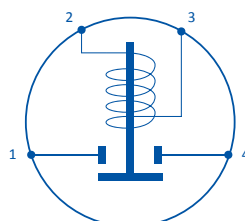

Specifications

- Voltage 12V, 24V, 36V Models
- Dimensions H 60 x D 64 x W 84
- Configuration SPST
- Modes Off/On
- Application Heavy Duty, Marine

Part Numbers 12V, 17.5 ohm

- M24117BX 85A Continuous
750A Make
100A Break

Part Numbers 24V, 71 ohm

- 24063BX 85A Continuous
120A Make
100A Break



SPST Continuous 12V 110A Latching Solenoid

24200BX

Features

- Pulse energise, stays on; pulse again, drops out.
- No heat generated due to coil taken out of circuit
- Copper Stud terminals 5/16"-24
- Insulated Coil terminals 10-32
- Strong plated steel housing
- Plated steel nuts and washers included
- Mounting holes 8mm x 15mm, 56mm CTC
- Mount with brand cap facing down
- Int. ratings: 10 sec On, 30 min Off

This special Solenoid toggles On and Off, and requires no current to maintain the continuity of the power circuit. Use it with a Mom function switch. Actuation of the momentary switch causes current to flow in the solenoid coil, locking the contact in place, maintaining the load circuit in an On position. A second actuation of the momentary switch releases the plunger, turning the load circuit Off.

Suggested to be used with momentary switches.

Specifications

- Voltage 12V
- Dimensions H 60 x D 79 x W 84
- Configuration SPST
- Application Heavy Duty, Mining

Part Numbers

- 24200BX 110A Continuous
110A (carry only)

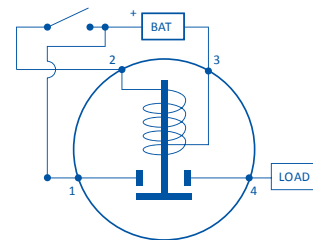

Remote Battery Isolator

In a two-battery system, use the Latching Solenoid to isolate the batteries from each other, and prevent battery drain from the higher into the lower. It has an advantage over electronic Battery Isolators, in that it will not produce a voltage drop during operation.

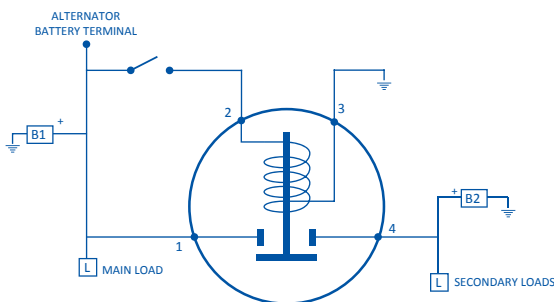

Remote Battery Disconnect

Use it as a remote Battery Disconnect Switch. This eliminates the need for heavy gauge wiring between the control panel and the battery.

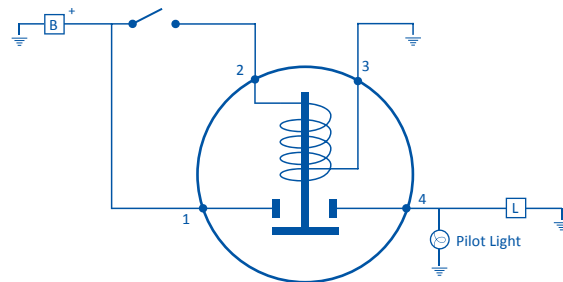

SPST Intermittent Duty Solenoid

24037BX

Features

- 3 Stud, Grounded stud earth
- SPST Normally open (one circuit) Off/On
- Copper Stud terminals 5/16"-24
- Internal grounded, Coil terminals 10-32
- Strong plated steel housing
- Plated steel nuts and washers included
- Mounting holes; 8mm x 15mm, 56mm CTC
- Mount with brand cap facing down
- Int. ratings: 10 sec On, 20 min Off

Specifications

- Voltage 12V, 24V, 36V Models
- Dimensions H 60 x D 64 x W 84
- Configuration SPST
- Modes Off/On
- Application Heavy Duty, Mining

Part Numbers 12V, 4.4 ohm

- 24037BX 750A Make
100A Break

Part Numbers 24V, 29 ohm

- 24063BX 375A Make
100A Break

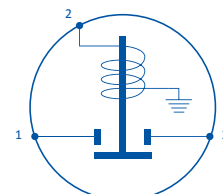

SPST Intermittent Duty Solenoid

M200BX

A Solenoid is an electromagnetic relay used in a direct current wiring system between a low current capacity switch and a high current load requirement.

Features

- 4 Stud, Insulated stud earth
- SPST Normally open (one circuit) Off/On
- Copper Stud terminals 5/16"-24
- Insulated Coil terminals 10-32
- Strong plated steel housing
- Plated steel nuts and washers included
- Mounting holes; 8mm x 15mm, 56mm CTC
- Mount with brand cap facing down
- Int. ratings: 10 sec On, 20 min Off

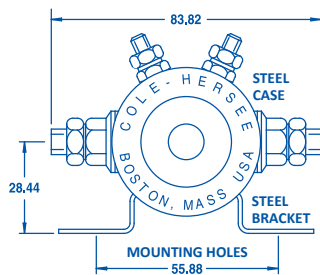

Specifications

- Voltage 12V, 24V Models
- Dimensions H 60 x D 64 x W 84
- Configuration SPST
- Modes Off/On
- Application Heavy Duty, Mining

Part Numbers 12V, 4.4 ohm

- M200BX 750A Make
100A Break
clear protective coating

Part Numbers 24V, 29 ohm

- 24008BX 120A Make
65A Break

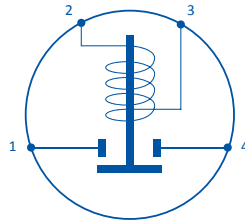

Marine, clear protective coating finish, M200BX

DPDT Twin Motor Reversing Intermittent Solenoid

24450BX

For reversing motors such as hoists, winches, ATVs and snowplow blades.

Two Solenoids in one for cost and space savings and simpler wiring. Two Integral Solenoids provide dynamic braking for permanent magnet motors when neither coil is energised.

Features

- F bracket, copper contacts
- Coil terminal blades, common ground
- Two blade coil terminals 5/16"-24
- Black nylon housing, nuts & washers
- Strong black nylon housing
- Plated steel nuts and washers included
- Mounting holes, 105mm CTC

Specifications

- Voltage 12V, 24V Models
- Amperage 75A@12V, 45A@24V
- Dimensions H 76 x D 83 x W 127
- Configuration DPST
- Modes Intermittent Duty

Part Numbers 12V

- 24450BX Boxed

Part Numbers 24V

- 24450-02BX Boxed

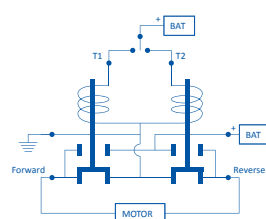
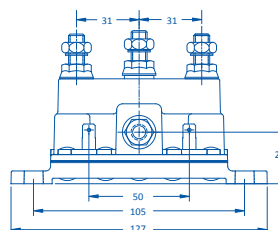

DPST Two Circuit Change Over Solenoid

24401BX

This Solenoid can be used for special application like forward and reverse systems in electric golf carts, garden tractors, fork lifts, trucks, winches, etc.

Features

- Normally open and normally closed contacts
- Used for forward and reverse systems
- Copper Stud terminals 5/16"-24
- Insulated Coil terminals 10-32
- Strong plated steel housing
- Plated steel nuts and washers included
- Mounting holes; 8mm x 15mm, 56mm CTC
- Int. ratings: 10 sec On, 30 min Off

Specifications

- Voltage 12V, 24V Models
- Amperage 35A Normally Closed, 85A Normally Open Continuous
- Dimensions H 60 x D 64 x W 84
- Configuration DPST
- Modes Continuous Duty
- Application Heavy Duty, Mining

Part Numbers 12V, 17.5 ohm

- 24401BX Boxed

Part Numbers 24V, 71 ohm

- 24402BX Boxed

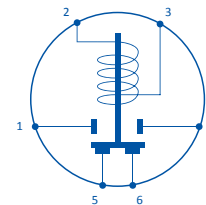
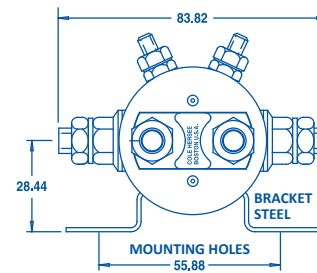

Motor Reversing Solenoid Wiring Diagram

Typical DC series wound permanent magnet circuit, using a pair of double-action Solenoids. Use pairs of the following Solenoids: 24401 (12V) or 24402 (24V).

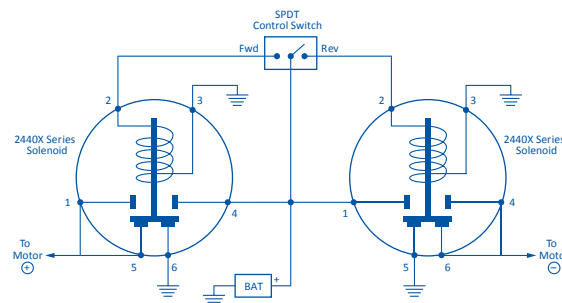

Twin Motor Forward & Reverse Relay Solenoid

24452BX

Features

- Dynamic braking when switch turned Off
- Heavy load current, dielectric strength 500V RMS
- Studs are securely protected in epoxy
- Low profile module (less than H 50mm)
- Fully sealed for harsh environment
- Rust and moisture resistant housing
- Tin plated brass studs, vibration resistance: 10-55Hz
- For intermittent operation use switch: Mom On/Off/Mom On
- For continuous use switch: On/Off/On
- Ideal for tarp, hoist, winch, fans and other motor reversing applications
- Automatically reverses the direction of motors

Reversing module carries a heavy load and is suitable for intermittent or continuous operation at 12 VDC.

Ideal for tarp or lift applications as well as for hoists, hatches, winches/ windlasses, snowplows, intake/exhaust fans, vehicle outriggers and many other direction reversing applications.

Specifications

- Voltage 12V
- Dimensions H 48 x D 74 x W 92
- Configuration SPST
- Modes Off/On
- Application Heavy Duty, Mining

Part Numbers

- 24452BX Boxed

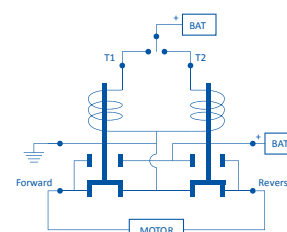

SPST 225A Heavy Duty Solenoid Continuous

24812BX

For use with heavy vehicles, materials handling, hydraulic systems, large DC machinery, and electric vehicles.

Features

- SPST Normally open (one circuit) Off/On
- Copper Stud terminals 5/16"-24
- Insulated Coil terminals 10-32, L bracket
- Strong plated steel housing
- Plated steel nuts and washers included
- Mounting holes 8mm x 15mm, 56mm CTC
- Int. ratings: 10 sec Of, 30 min Off

Specifications

- Voltage 12V, 24V Models
- Dimensions H 103 x D 69 x W 100
- Configuration SPST
- Modes Continuous Duty
- Application Heavy Duty

Part Numbers 12V, 7.7 ohm

- 24812BX 225A Continuous
750A Make
150A Break

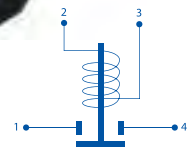

SPST 12V 100A Continuous Nylon Solenoid

24612-10BX

Features

- SPST Normally open (one circuit) Off/On
- 4 Stud, Copper Stud terminals 5/16"-24
- Insulated coil terminal 10-32
- Glass black nylon housing, F bracket
- Plated steel nuts and washers included
- Mounting holes 8mm x 15mm, 56mm CTC
- Int. ratings: 10 sec On, 30 min Off

Specifications

- Voltage 24V
- Amperage 100A Continuous
400A Inrush
100A Make and Break
- Dimensions H 65 x D 47 x W 76

Part Numbers

- 24612-10BX 12V, 16 ohm

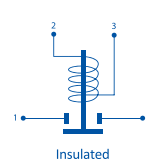

SPST 24V 100A Continuous Nylon Solenoid

24624-10BX

Features

- SPST Normally open (one circuit) Off/On
- 4 Stud, Copper Stud terminals 5/16"-24
- Insulated coil terminal 10-32
- Glass black nylon housing, F bracket
- Plated steel nuts and washers included
- Mounting holes 8mm x 15mm, 56mm CTC
- Int. ratings: 10 sec On, 30 min Off

Specifications

- Voltage 24V
- Amperage 100A Continuous
200A Inrush
100A Make and Break
- Dimensions H 65 x D 47 x W 76

Part Numbers

- 24624-10BX 24V, 64 ohm

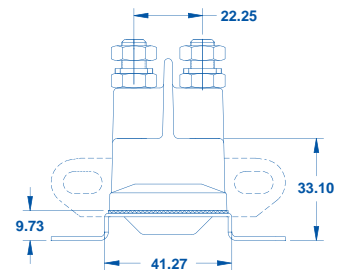
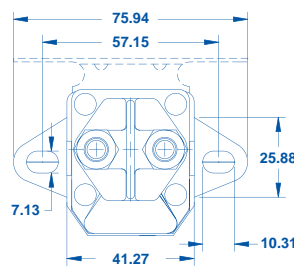
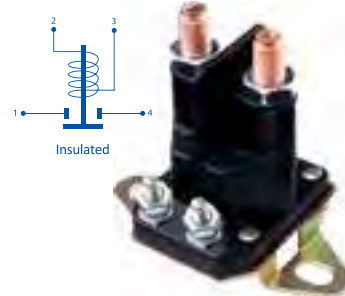

SPST 12V 100A Continuous Nylon Solenoid

24512-10BX

Features

- SPST Normally open (one circuit) Off/On
- 2 Blade, 2 Stud, Copper Stud terminals 5/16"-24
- Insulated coil terminal 10-32
- Glass black nylon housing, F bracket
- Plated steel nuts and washers included
- Mounting holes 8mm x 15mm, 56mm CTC
- Int. ratings: 10 sec On, 30 min Off

Specifications

- Voltage 12V
- Amperage 100A Continuous
400A Inrush
100A Make and Break
- Dimensions H 65 x D 47 x W 76

Part Numbers

- 24512-10BX Boxed

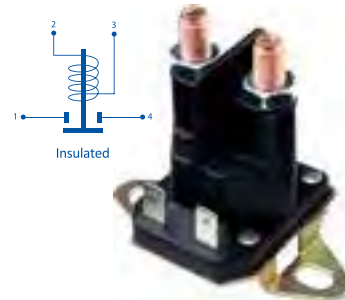

SPST 12V 100A Continuous Nylon Solenoid

24612BX

Features

- SPST Normally open (one circuit) Off/On
- 4 Stud, Copper Stud terminals 5/16"-24
- Insulated coil terminal 10-32
- Glass black nylon housing, L bracket
- Plated steel nuts and washers included
- Mounting holes 8mm x 15mm, 56mm CTC
- Int. ratings: 10 sec On, 30 min Off

Specifications

- Voltage 12V
- 24059BX 100A Continuous
400A Inrush
100A Make and Break
- Dimensions H 65 x D 47 x W 76

Part Numbers

- 24612BX Boxed

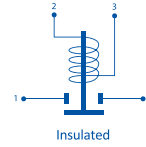

SPST 12V 200A Intermittent Nylon Solenoid

24512-03BX

Features

- SPST Normally open (one circuit) Off/On
- 2 Blade, 2 Stud, Copper Stud terminals 5/16"-24
- Insulated coil terminal 10-32
- Glass black nylon housing, L bracket
- Plated steel nuts and washers included
- Mounting holes 8mm x 15mm, 56mm CTC
- Int. ratings: 20 sec On, 40 min Off

Specifications

- Voltage 12V
- Amperage 200A Intermittent
500A Inrush
200A Make and Break
- Dimensions H 65 x D 47 x W 76

Part Numbers

- 24512-03BX Boxed

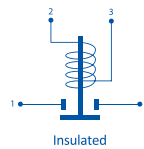

SPST 12V 200A Intermittent Nylon Solenoid

24612-03BX

Features

- SPST Normally open (one circuit) Off/On
- 4 Stud, Copper Stud terminals 5/16"-24
- Insulated coil terminal 10-32
- Glass black nylon housing, L bracket
- Plated steel nuts and washers included
- Mounting holes 8mm x 15mm, 56mm CTC
- Int. ratings: 20 sec On, 40 min Off

Specifications

- Voltage 12V
- Amperage 200A Intermittent
500A Inrush
200A Make and Break
- Dimensions H 65 x D 47 x W 76

Part Numbers

- 24612-03BX Boxed

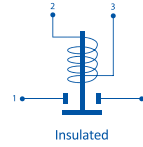

SPST 12V 200A Intermittent Nylon Solenoid

24612-13BX

Features

- SPST Normally open (one circuit) Off/On
- 2 Blade, 2 Stud, Copper Stud terminals 5/16"-24
- Insulated coil terminal 10-32
- Glass black nylon housing, F bracket
- Plated steel nuts and washers included
- Mounting holes 8mm x 15mm, 56mm CTC
- Int. ratings: 20 sec On, 40 min Off

Specifications

- Voltage 12V
- Amperage 200A Intermittent
500A Inrush
200A Make and Break
- Dimensions H 65 x D 47 x W 76

Part Numbers

- 24612-13BBX Boxed

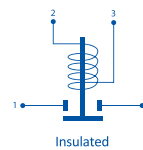

Circuit Breakers



CIRCUIT BREAKERS

Cole Hersee Circuit Breakers and compatible Mounting Brackets are designed and engineered for responsive performance over a long period. Casings are manufactured from either high quality plated steel or durable plastic. Mounting Brackets are available in heavy gauge steel or lightweight moulded plastic.

All electrical circuits need protection so an overload condition can be detected and the circuit opened until the overload can be corrected. The inexpensive protection of a Circuit Breaker can save the failure of an expensive piece of equipment or an even greater loss due to an electrical fire.

Generation of heat is a result of an electrical overload. A fuse has a metal element which is designed to melt and open the circuit at a relatively low heat. Two different elements of metals are used in a Circuit Breaker. The elements bend and separate due to heat, thus opening the circuit. A melted fuse must be replaced, but a Circuit Breaker can continue to function after the cause of the overload is corrected.

Most electrical systems have numerous circuits: each circuit can be operated independently, therefore each circuit needs protection. With direct current circuits in a battery powered vehicle, circuit protection is very important. The cost of an engine starter or other equipment in a car or truck compared to the cost of a Circuit Breaker, makes the Circuit Breaker an obvious and necessary addition.

Circuit Breakers are the choice for protection in heavy duty vehicles and equipment. There are more than 20 types of Circuit Breakers to fit the requirements of both equipment design engineers and aftermarket replacement—suitable for vehicles on and off the road, equipment in the field and the construction site.

SAE J553 Circuit Breaker Types

Type I: Automatic: Cycle or continuously reset until the overload is corrected.

Type II: Remains open as long as the overload exists, the unit resets when the situation is corrected.

Type III: Manual: Remains open until the unit is manually reset by pushing a button.

Circuit Breaker Type Options

Type I

- 12 volt, steel housing, bracket along case
- 12 volt, steel housing, snap-in mounting
- 12 volt, steel housing, plug-in mounting
- 24 volt, steel housing, bracket along case
- 24 volt, steel housing, snap-in mounting
- 12 volt, steel housing, dual circuit breaker, bracket along case
- 12 volt, plastic housing, bracket along case
- 12 volt, plasticised housing, no bracket
- 12 volt, plasticised housing, bracket along case

Type II

- 12 volt, steel housing, bracket along case
- 12 volt, steel housing, snap-in mounting
- 12 volt, plastic housing, plug-in mounting
- 12 volt, plastic housing, fuse clip snap-in mounting

Type III

- 12 volt, plastic housing, bracket along case
- 12 volt, plastic housing, snap-in mounting

Please note: some of the above mentioned options may not be shown in this catalogue.

Metal or Plastic Body?

There's not a lot of difference between metal body and plastic body circuit breakers: both are about the same weight and structural integrity, but the plastic type is more resistant to denting and corrosion. One type of plastic-body breaker, the 30427 series, is also weather-resistant.

SAE J553 FOR CIRCUIT BREAKERS

Society of Automotive Engineers Standard J553 defines testing and performance requirements for three types of Circuit Breakers up to 50A for 6V, 12V, and 24V operation: Type I, Type II, and Type III.

Conforming Circuit Breakers

- Must carry 100% of rated current continuously for a minimum of one hour
- Must open at 135% of rated current within 30 minutes
- Must open at 200% of rated current within one minute

The specific current capacity of the Circuit Breaker is a function of the particular electrical system being utilised. It is recommended that the actual performance be verified through testing experimentally in the proposed application.

Several factors should be considered:

Wire and Terminations

The connecting wires and their terminations will affect the heat dissipation characteristic of the breakers. Deviations from the breaker application specifications may affect the current carrying capacity or the effective limitation of current during overload cycling.

Voltage Rating

The rating marked on breakers is the maximum value recommended. Use at higher voltages may significantly shorten product life under load conditions, and possibly cause damage to your equipment.

Circuit Protection

Components are thermal devices that create an open circuit under overcurrent conditions. They are deliberately designed as the sacrificial weakest link in a system, protecting components from costly damage. It is important to select a fuse or circuit breaker with a current rating equal to or lower than the lowest current rating of any part of the circuit.

Ambient temperature

Circuit Breakers are thermal devices. Changes in the ambient temperature will have an effect on the current carrying capacity and on the effective limitation of current during overload cycling.

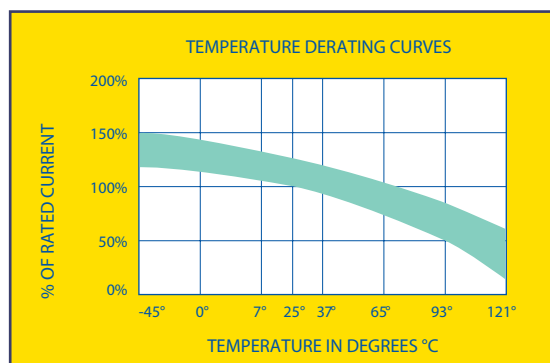
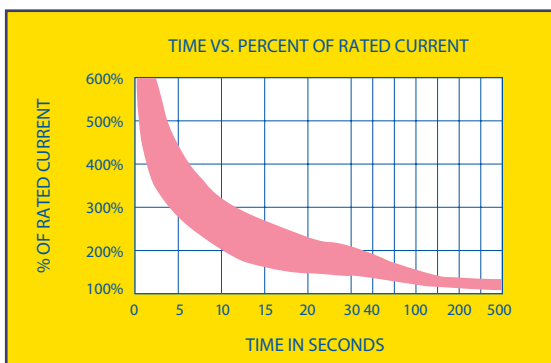

All Cole Hersee Circuit Breakers conform to SAE Standard J553.

Metal Thermal Reset Cycling Circuit Breakers

30055-10BX

These metal Type I Circuit Breakers cycle or continuously reset until the overload is corrected.

Features

- Plated steel case and mounting brackets
- Flange mount, stud terminals 10-32
- Short stud – BAT, Long stud – LOAD

Specifications

- Voltage 12V, 24V
- Amperage 6A, 10A, 15A, 20A, 25A, 30A, 40A, 50A
- Dimensions H 31 x D 20 x W 51

Part Numbers 12V

- 30055-10BX 10A
- 30055-15BX 15A
- 30055-20BX 20A
- 30055-25BX 25A
- 30055-30BX 30A
- 30055-40BX 40A
- 30055-50BX 50A

Part Numbers 24V

- 30172-20B 20A



Metal Plug In Cycling ATC/ATO Circuit Breakers

30409-10BX

These metal Type I Circuit Breakers cycle or continuously resets until the overload is corrected.

Terminals are grooved so that they can be easily snapped off with pliers to fit the electrical blocks of different vehicles.

Use as is long terms for Kenworth trucks.

Features

- Plated steel case, plug in mounting
- Cut on grooves for length of terminals

Specifications

- Voltage 12V
- Amperage 10A, 15A, 20A, 25A, 30A
- Dimensions H 19 x D 10 x W 21

Part Numbers 12V

- 30409-10BX 10A
- 30409-15BX 15A
- 30409-20BX 20A
- 30409-25BX 25A
- 30409-30BX 30A

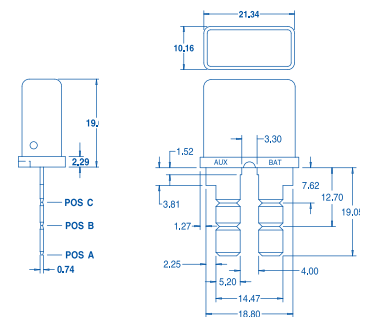

Connectors & Electrical

The Cole Hersee range includes high quality connectors and electrical equipment such as heavy duty trailer connectors, battery studs and jumpers, headlight connectors and electronic units.

Cole Hersee trailer connectors are built to withstand the rigors of trucking thousands of kilometers in dust and dirt, heat and cold, yet maintain the all-important electrical continuity between vehicle and trailer.



7 Pole Trailer Connector Wiring

| | | |
|---|-------------------------------|--------|
| 1 | Earth return | White |
| 2 | Reversing lamp | Black |
| 3 | Left hand turn signal | Yellow |
| 4 | Stop lamps | Red |
| 5 | Right hand turn signal | Green |
| 6 | Rear, clearance, marker lamps | Brown |
| 7 | Service brakes | Blue |



CONNECTORS & ELECTRICAL

7 Pole Heavy Duty ABS Body Trailer Plug

12311BX

Features

- Glass filled plastic housing prevents rust and corrosion
- Spring grip design with self-adjusting spring band for uniform contact with socket pins.
- Contacts flat for best alignment and connection
- O-ring at plug end prevents moisture from reaching contacts
- Strain relief isolates connections on terminals from mechanical strain.
- Grommet seal provides additional moisture protection

Specifications

- Dimensions H 40 x D 156 x W 76
- Approvals ADR 42, SAE J560b

Part Numbers

- 12311BX Boxed

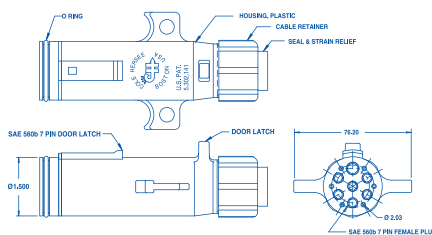

7 Pole Heavy Duty ABS Body Trailer Socket

12080BX

Features

- Glass filled plastic housing prevents rust and corrosion
- Insulated circuit contacts (not self-grounding)
- Spring loaded cover
- Solid brass contact pins
- Earth Pin 8AWG others 10AWG

Specifications

- Dimensions H 84 x D 54 x W 104
- Approvals ADR 42, SAE J560b

Part Numbers

- 12080BX Boxed

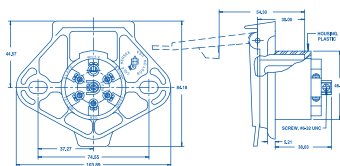

7 Pole Heavy Duty Metal Body Trailer Plug

12092BX

Features

- Die-cast metal housing, quick release
- Floating contacts for best alignment
- Plated steel cable protector provides strain relief and abrasion protection
- Cable clamp holds cables firmly in place
- Earth Pin 8AWG others 10AWG

Specifications

- Dimensions H 40 x D 200 x W 76
- Approvals ADR 42, SAE J560b

Part Numbers

- 12092BX Boxed



7 Pole Heavy Duty Metal Body Trailer Plug

1255B

Features

- Die-cast metal housing, spring grip
- Plated steel cable protector provides strain relief and abrasion protection
- Cable clamp holds cables firmly
- Unique brass female contact with self-adjusting spring band, ensures uniform contact with socket pins
- Greater contact area for increased electrical efficiency
- Coupling and uncoupling are easier, creates a wiping action that eliminates dirt and dust

Specifications

- Dimensions H 40 x D 225 x W 68
- Approvals ADR 42, SAE J560b

Part Numbers

- 1255B Boxed

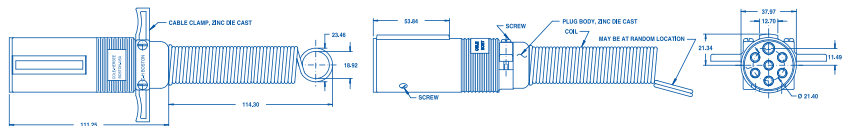

7 Pole Heavy Duty Metal Body Trailer Socket

12063BX

Features

- Corrosion resistant die-cast metal
- Spring loaded cover
- Solid brass contact pins
- Earth Pin 8AWG others 10AWG

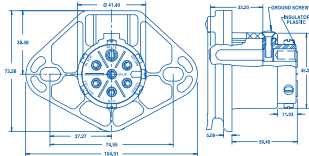

Specifications

- Dimensions H 84 x D 54 x W 104
- Approvals ADR 42, SAE J560b

Part Numbers

- 12063BX Boxed
- 12063-01BX Split pin contacts



Heavy Duty Battery Feed Studs

M46211-01BX

These Battery Feed Studs are designed to bring power through fire walls and bulk heads.

Features

- Impact resistant threaded mount bushing
- Self locking mounting nut
- Suits panel up to 9mm thick
- Hole Ø Flats 28.5mm, Body 36mm
- Double sided cable stud 3/8"-16, D 9.5mm, L 15mm
- Includes lock washer & brass hexnut

Specifications

- Voltage 6V - 48V Multivoltage
- Dimensions H 52 x D 40 x W 40

Part Numbers

- M46211-01BX Black Negative
- M46211-RBX Red Positive



Three Pole Sealed Beam Connector

3028-02BX

Features

- Sealed beam connector without wires
- Three pole headlamp type
- High temperature resistant material with bronze contacts
- Pre-wired version available

Specifications

- Dimensions H 28 x D 16 x W 29

Part Numbers

- 3028-02BX Boxed
- 3029BX Pre-wired



Heavy Duty Battery Jumper Studs

M46210-03BX

A Heavy Duty Battery Jumper Stud allows direct connection to the battery and has accessible locations inside or outside the vehicle.

Features

- Impact resistant threaded mount bushing
- Self locking mounting nut
- Suits panel up to 9mm
- Hole Ø Flats 28.5mm, Body 36mm
- Cable stud 3/8"-16, D 9.5mm, L 15mm
- Includes lock washer & brass hexnut
- Brass jumper stud 20.6mm, H 29mm

Specifications

- Voltage 6V - 48V Multivoltage
- Dimensions H 67 x D 40 x W 40

Part Numbers

- M46210-03BX Black Negative
- M46210-02BX Red Positive



ABS Base Brass Terminal Strip Connector

M4755BX

Features

- Moisture-repellent molded fibre base
- Nickel-plated brass terminal links
- 5 Circuit diagram

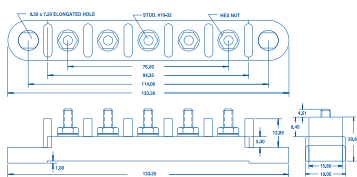

Specifications

- 5 Circuit H 24 x D 19 x W 133
- 8 Circuit H 21 x D 16 x W 162
- 10 Circuit H 21 x D 16 x W 197

Part Numbers

- M4755BX 5 Circuit
- M4721BX 8 Circuit
- M4722BX 10 Circuit





Cole Hersee®
A Littelfuse Brand

Partnership

ESG Asia Pacific are currently, and have been, the exclusive Australian distributor of Cole Hersee for over 20 years!

Along with Cole Hersee, ESG Asia Pacific also distributes other well-known automotive brands including ECCO, Code 3, Britax and Xray Vision.

ESG Asia Pacific is part of the ECCO Safety Group which globally serves more than 3,000 OEM and aftermarket customers.



v 21.01



ESG Asia Pacific is part of the ECCO Safety Group of companies.

Britax is the registered trademark of, and is used under licence from, a member of the Britax group of companies.